

# I.N.G. FIXATIONS

FRENCH CREATOR AND MANUFACTURER *since 1985!*





→ THE COMPANY

SINCE

1985

2 MANUFACTURING SITES :

**CREATOR**

**AND MANUFACTURER  
OF FASTENERS**

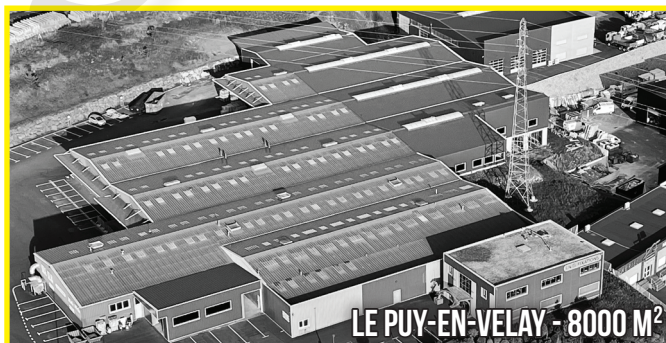

LE PUY-EN-VELAY - 8000 M<sup>2</sup>



MONISTROL-SUR-LOIRE - 5000 M<sup>2</sup>

SOME NUMBERS ...

- **38** YEARS OF EXPERIENCE

- **20** MILLIONS OF € OF SALES REVENUE

- **4 000** REFERENCED PRODUCTS

- AROUND **5 000** DISTRIBUTORS

- PRODUCTS EXPORTED TO MORE THAN **30** COUNTRIES

- **100%** OF BOXES ARE MADE FROM RECYCLABLE PLASTIC

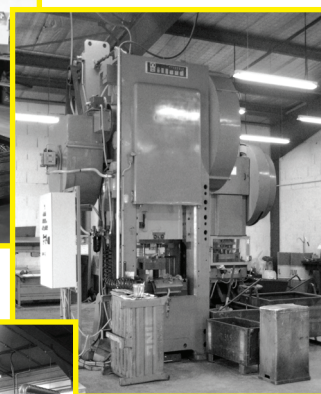
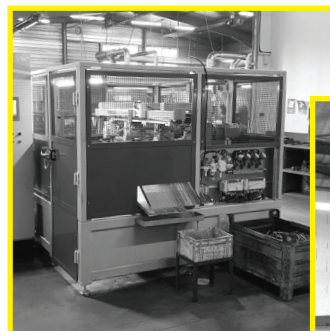

ISO 9001 STANDARD  
IN PROGRESS



# OUR INNOVATIONS

It is by listening to craftsmen that our innovations are born !

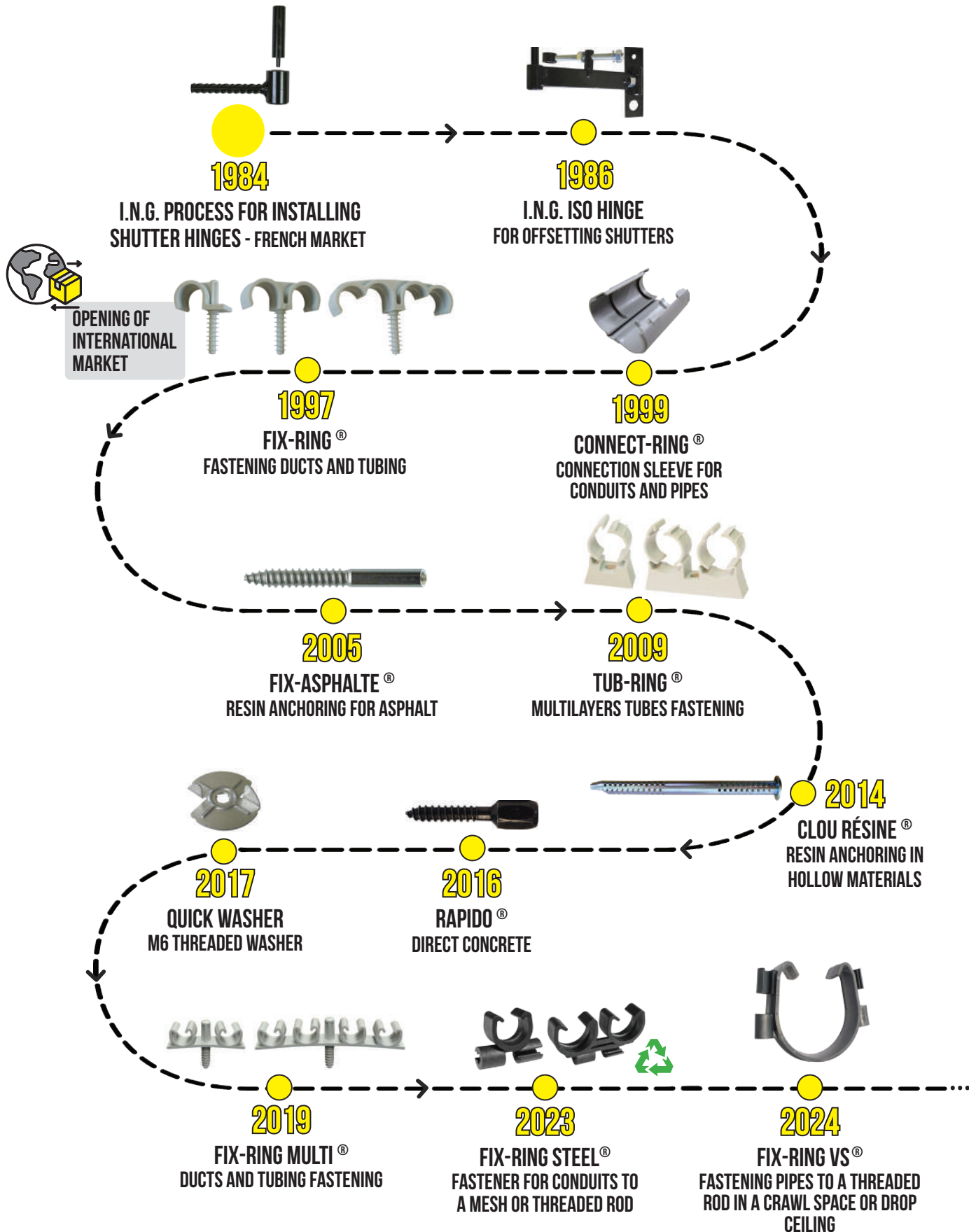

# INTERNATIONAL EXHIBITIONS FAIRS



WEBSITE  
[www.ingfixations.fr](http://www.ingfixations.fr)



Scan me!



YOUTUBE













ENGLISH  
VERSION























**DISCOVER** OUR :  
PRODUCTS  
TECHNICAL DOCUMENTS  
CATALOGS / BROCHURES  
NEWS  
OUR HISTORY















## ELECTRICIAN

<b>FIX-RING®</b>  Page 5	<b>FIX-RING MULTI®</b>  Page 6	<b>FIX-RING +®</b>  Page 7	<b>FAST-RING</b>  Page 8	<b>CONNECT-RING®</b>  Page 9	<b>ECO-RING</b>  Page 10
<b>FIX-ELEC®</b>  Page 11	<b>CLOU-ELEC</b>  Page 12	<b>TOOL FOR CABLE TIE</b>  Page 13	<b>FIX-RING STEEL®</b>  Page 14		

## PLUMBER

<b>FIX-RING STEEL®</b>  Page 14	<b>FIX-RING VS®</b>  Page 15	<b>FIX-RING®</b>  Page 16	<b>FIX-RING MULTI®</b>  Page 17	<b>TUB-RING®</b>  Page 18	<b>FIX-RING CLIM®</b>  Page 19
<b>WALL PLUG FOR TAP</b>  Page 20	<b>WALL PLUG FOR TAP WITH INSULATION</b>  Page 21	<b>WALL PLUG FOR WATER HEATING SYSTEM</b>  Page 22	<b>WALL PLUG FOR WATER HEATING SYSTEM WITH LINING</b>  Page 23	<b>M6 AND M8 UNIVERSAL FIXING</b>  Page 24	<b>CAST IRON RADIATOR WALL BRACKET</b>  Page 25
<b>ADJUSTABLE CONSOLE FOR FIXING COLLECTIVE WASH BASIN</b>  Page 26	<b>WELDED AIR-CONDITIONING BRACKET</b>  Page 27	<b>IZY 7-8-10®</b>  Page 28	<b>CONNECTION SCREW M10</b>  Page 29	<b>CONNECTOR ANGLED M7 &amp; M8</b>  Page 30	<b>JUNCTION FITTING</b>  Page 31
<b>M6 QUICK-FIX WASHER + CAVITY TOGGLE</b>  Page 32	<b>CLAMP</b>  Page 33				

## FASTENERS

<b>RAPIDO®</b>  Page 34	<b>SPEEDY-FIX®</b>  Page 35	<b>FIX-FOURRURE</b>  Page 36	<b>FIX-ASPHALT®</b>  Page 37	<b>A4 STAINLESS STEEL RESIN SOCKET</b>  Page 38	<b>FIX-STORE®</b>  Page 39
<b>ISOL-FIX®</b>  Page 40	<b>PRATICO®</b>  Page 41	<b>POLYAMIDE THROUGH PLUG</b>  Page 42	<b>GUTTER FIXINGS</b>  Page 43	<b>EXTERNAL THERMAL INSULATION BLOCK</b>  Page 44	<b>FIX-GABION</b>  Page 45
<b>SIGNAGE PANEL FIXING</b>  Page 46	<b>A4 STAINLESS STEEL</b>  Page 47				

# FIX-RING® - THE ORIGINAL

## ELECTRICAL SHEATH AND TUBE



- ▶ Quick and easy : drill, hammer, done !
- ▶ Colour : grey
- ▶ Drilling  $\varnothing$  8 mm
- ▶ 100 % Nylon - Polyamide 6

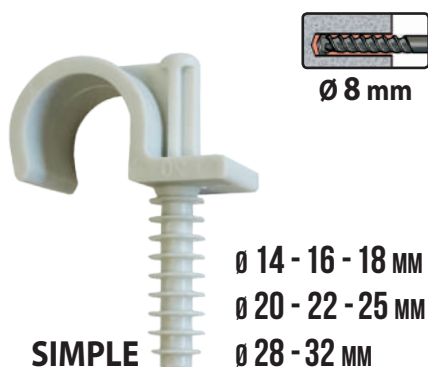

FIX-RING®	Diameter (mm)	Quantity per box	Quantity of boxes per carton	Compatibility
Simple	14	100	16	
	16	100	16	ICT pipe - IRO tube $\varnothing$ 16
	18	100	16	Sheathed copper tube $\varnothing$ 12-14
	20	100	16	Sheathed copper tube $\varnothing$ 14-16 ICT pipe - IRO tube $\varnothing$ 20
	22	100	16	Sheathed copper tube $\varnothing$ 16-18
	25	100	12	ICT pipe - IRO tube $\varnothing$ 25
	28	100	12	Sheath $\varnothing$ 28
	32	50	16	ICT pipe - IRO tube $\varnothing$ 32

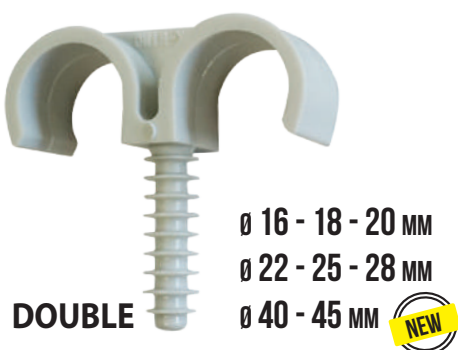

FIX-RING®	Diameter (mm)	Quantity per box	Quantity of boxes per carton	Compatibility
Double	16	100	16	ICT pipe - IRO tube $\varnothing$ 16
	18	100	12	Sheathed copper tube $\varnothing$ 12-14
	20	100	12	Sheathed copper tube $\varnothing$ 14-16 ICT pipe - IRO tube $\varnothing$ 20
	22	100	9	Sheathed copper tube $\varnothing$ 16-18
	25	100	9	ICT pipe - IRO tube $\varnothing$ 25
	28	50	12	Sheath $\varnothing$ 28
	40	20	12	Insulated multilayer $\varnothing$ 40
	45	20	12	Insulated multilayer $\varnothing$ 45

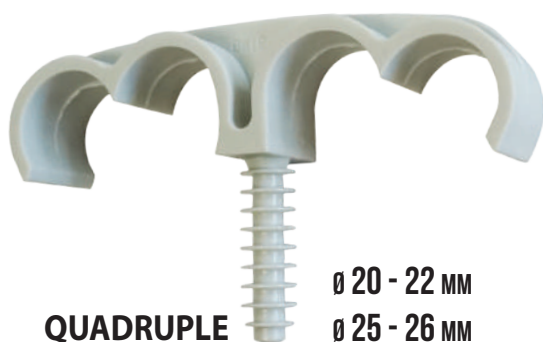

FIX-RING®	Diameter (mm)	Quantity per box	Quantity of boxes per carton	Compatibility
Quadruple	20 - 22	50	12	Pipes to the switchboard
	25 - 26	50	9	

CUSTOM'S CODE : 39269097

# FIX-RING MULTI<sup>®</sup>

FIXING OF IRO TUBE AND ICT SHEATH

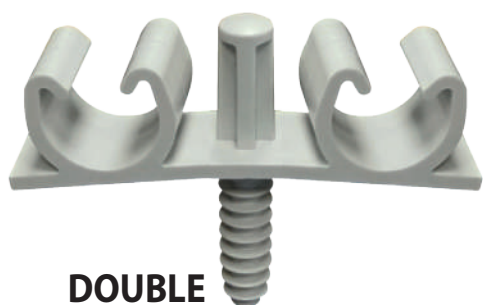
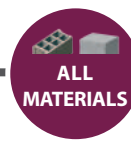

**DOUBLE**

Ø 16 - 20 MM

Ø 22 - 26 MM

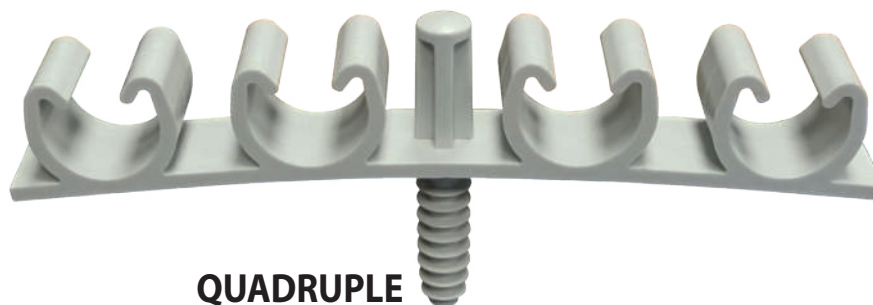

**QUADRUPLE**

Ø 16 - 20 MM

Ø 22 - 26 MM



Ø 16 to 20 : Ø 8 MM

Ø 22 to 26 : Ø 10 MM



- ▶ Quick and easy : drill, hammer and then clip pipe or duct into place with your hand
- ▶ Multi-diameter : one product for different diameters
- ▶ Safer work : fewer falls
- ▶ Reinforced strike zone
- ▶ Colour : grey
- ▶ 100% nylon - Polyamide 6

CUSTOM'S CODE : 39269097

# FIX-RING+<sup>®</sup>

REMOVABLE FIXING FOR ELECTRICAL TUBE



**SECURITY :  
THE TUBE  
IS BLOCKED**

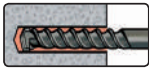

ø 8 mm

ø 16 - 20 - 25 mm



DELIVERED WITH THE INSTALLATION TOOL



- ▶ Quick and easy : drill, hammer, done !
- ▶ Secure : conduit firmly locked in place and not just clipped
- ▶ Can be removed with a setting tool or screwdriver
- ▶ UV - stabilised
- ▶ Fire-retardant V0 Classification
- ▶ Colour : grey
- ▶ Drill hole ø 8 mm
- ▶ 100 % Nylon - Polyamide 6

CUSTOM'S CODE : 39269097



# FAST-RING

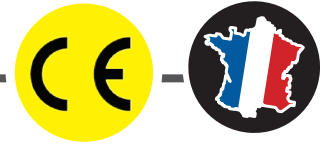

CONNECTING A TUBE TO AN EXISTING TUBE

AVOID DRILLING  
ANOTHER HOLE  
TO INSTALL  
ANOTHER TUBE

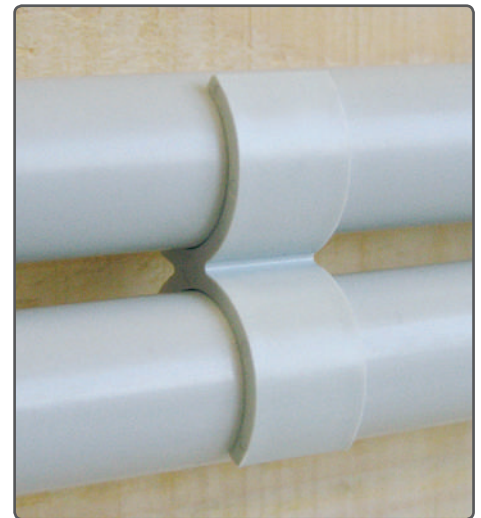

- ▶ Quick and easy : connect a new tube directly to the existing tube without having to drill any holes
- ▶ Perfectly straight
- ▶ Colour : grey
- ▶ 100 % Nylon - Polyamide 6

CUSTOM'S CODE : 39269097

# CONNECT-RING<sup>®</sup>

CONNECTING SLEEVE FOR IRO TUBE AND ICT SHEATH

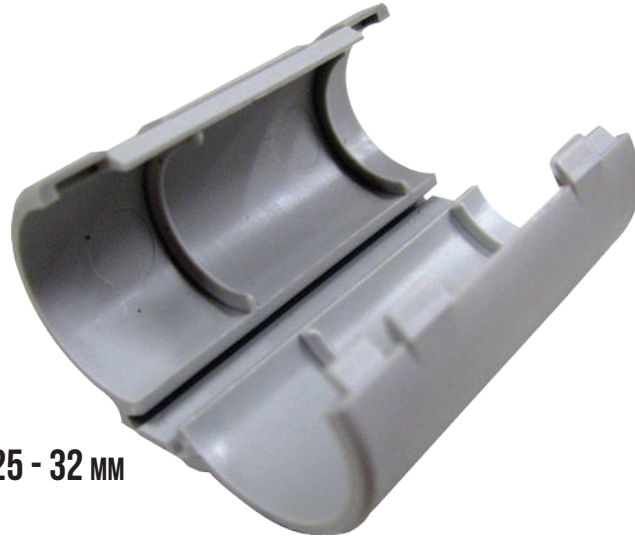

∅ 16 - 20 - 25 - 32 mm

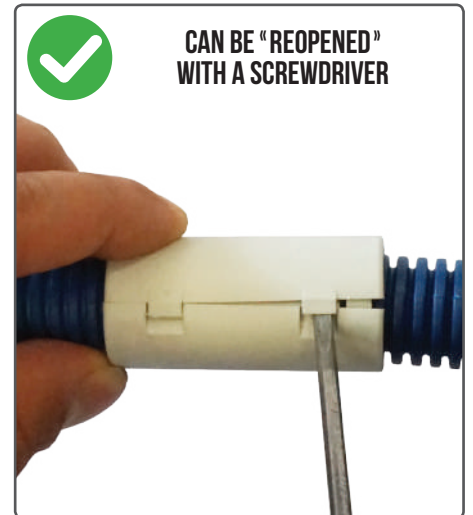
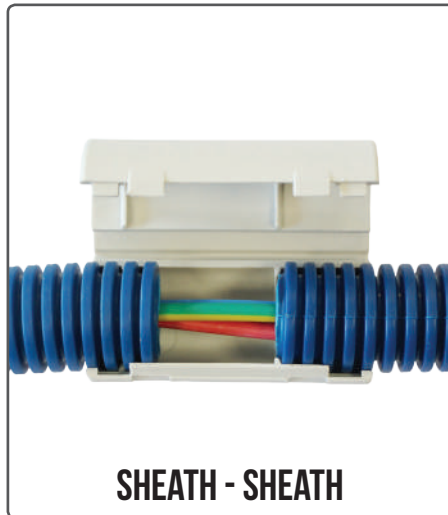

- ▶ No more unusable ducts
- ▶ Quick and easy !
- ▶ Removable
- ▶ Can be used even if wires are exposed
- ▶ Fire-retardant V2 Classification
- ▶ Colour : grey
- ▶ Length : **50 mm**
- ▶ 100 % Nylon - Polypropylene



CUSTOM'S CODE : 39269097

# ECO-RING

CONNECTING SLEEVE FOR ICT SHEATH

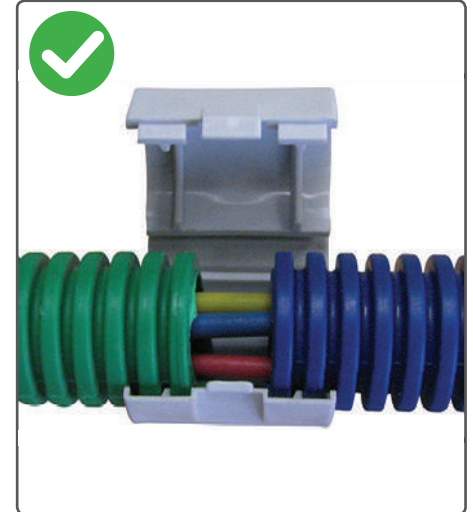
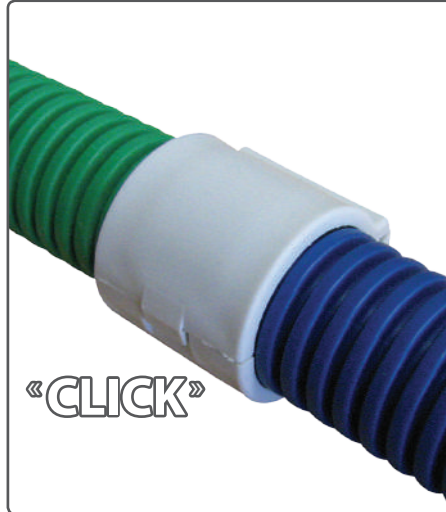
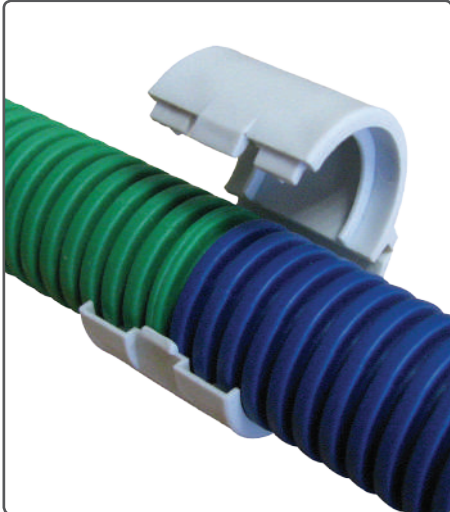
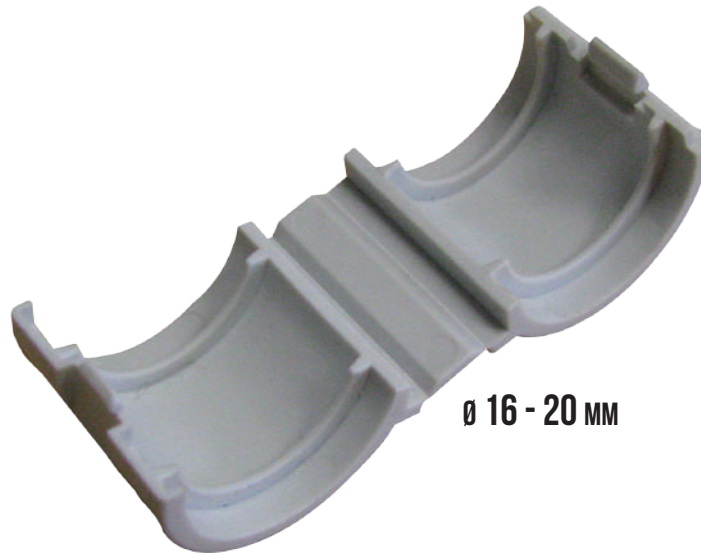
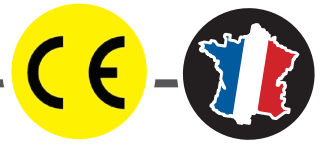

- ▶ No more unusable ducts
- ▶ Quick and easy !
- ▶ Removable
- ▶ Can be used even if wires are exposed
- ▶ Fire-retardant V2 Classification
- ▶ Colour : grey
- ▶ Length : **22 mm**
- ▶ 100 % Nylon - Polypropylene

CUSTOM'S CODE : 39269097

# FIX-ELEC<sup>®</sup>

FIXING FOR ELECTRICAL PVC MOULDINGS



Ø 5 mm

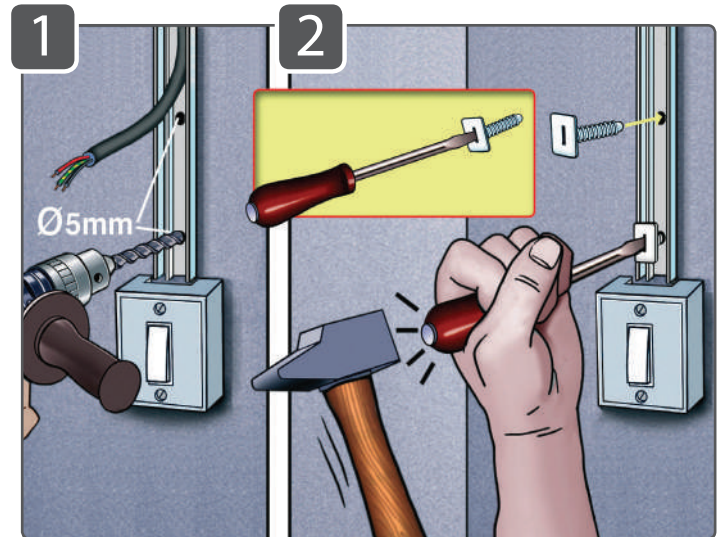
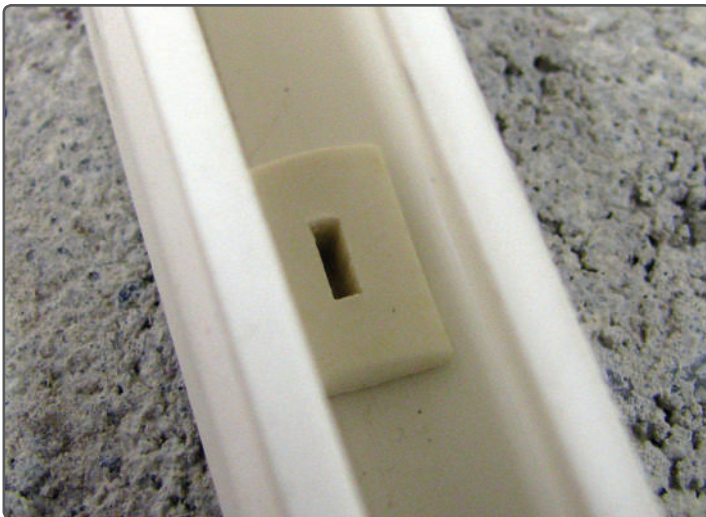

- ▶ Quick and easy : drill, hammer, done !
- ▶ Registered trademark
- ▶ 100% nylon - Polyamide 6
- ▶ Colour : white
- ▶ Drill hole **Ø 5 mm**
- ▶ Use with flat-head screwdriver n° 0,8 x 4

CUSTOM'S CODE : 39269097

# CLOU-ELEC

FIXING FOR PVC CHANNEL

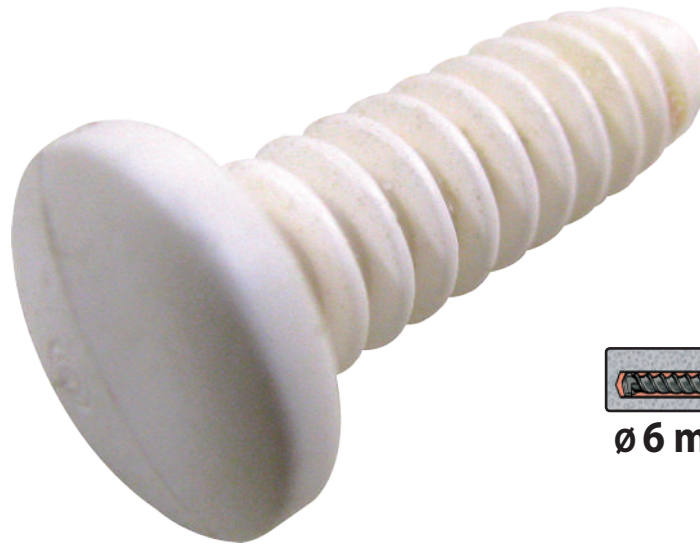

Ø 6 mm

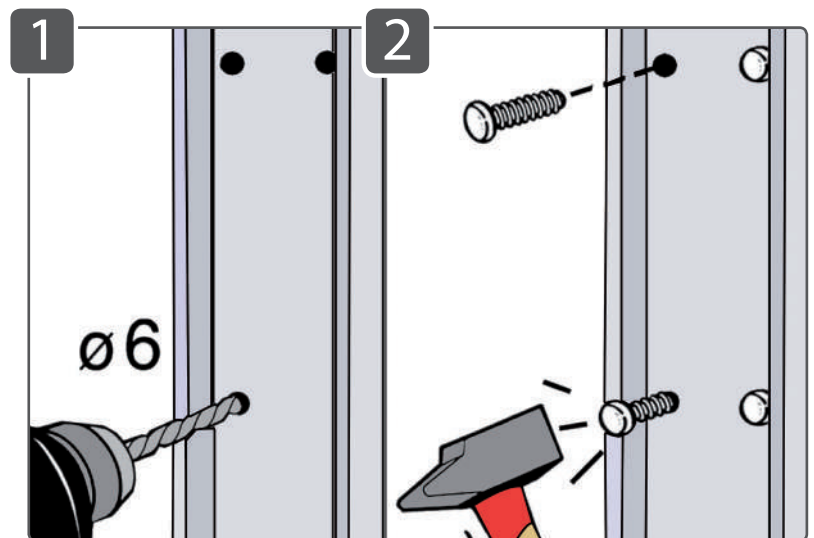

- ▶ Quick and easy : drill, hammer, done !
- ▶ 100% nylon - Polyamide 6
- ▶ Colour : white
- ▶ Drill hole Ø 6 mm

CUSTOM'S CODE : 39269097

# TOOL FOR CABLE TIE



- ▶ Allow effortless tightening and cutting of cable tie
- ▶ Robust - High quality

CUSTOM'S CODE : 8203200



# FIX-RING STEEL<sup>®</sup>

INSTALLATION ON WELDED MESH OR THREADED ROD



100% RECYCLED PRODUCT



SIMPLE



DOUBLE

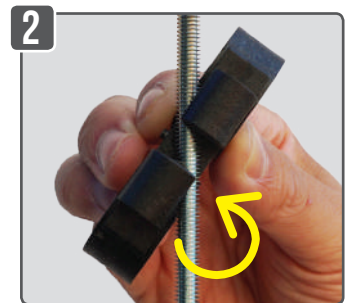
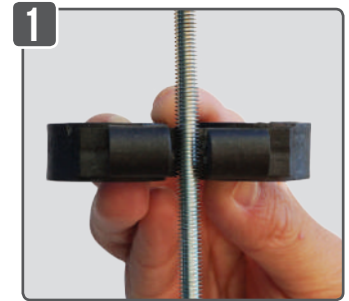

FLOOR INSTALLATION

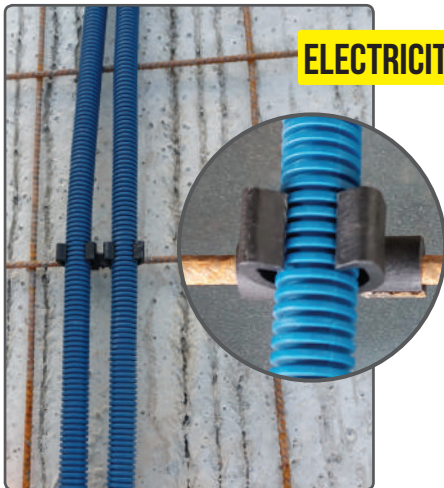

CONCRETE IRON

FALSE CEILING



THREADED ROD

ELECTRICITY / PLUMBING

Implementation quick and easy :

To be clipped directly onto the welded mesh or threaded rod

CUSTOM'S CODE : 39269097

# FIX-RING VS<sup>®</sup>

**FASTENING DRAINAGE PIPES TO THREADED ROD IN A CRAWL SPACE OR DROP CEILING**

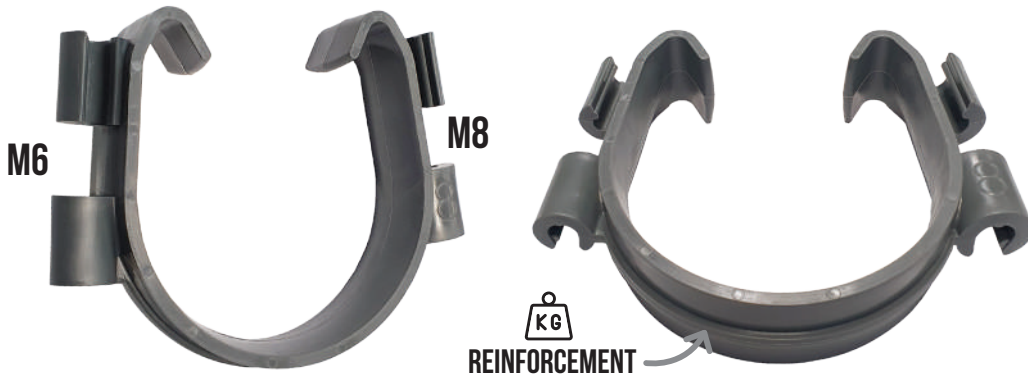

**Easy and quick set up :**  
clip the fastener onto the threaded rod  $\varnothing 6$  or  $\varnothing 8$

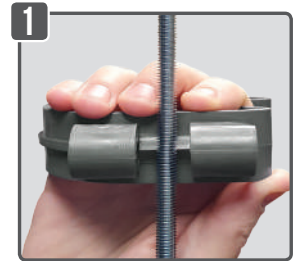

**INSTALLATION UNDER HOLLOW CONCRETE FLOOR BEAM**



**INSTALLATION UNDER POLYSTYRENE FLOOR BEAM - DRILLING THROUGH THE SLAB**



**INSTALLATION UNDER PLASTIC FLOOR BEAM - DRILLING FROM UNDERNEATH**

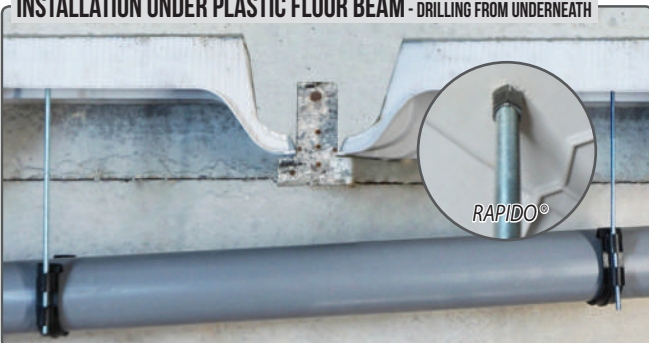

Slope adjustment by screwing / unscrewing the FIX-RING VS<sup>®</sup>



Also possible on slab exit : FIX-RING VS<sup>®</sup> upside down

**CUSTOM'S CODE : 39269097**



# FIX-RING® - THE ORIGINAL

## PLUMBING SHEATH AND TUBE

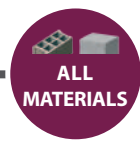

- ▶ Quick and easy : drill, hammer, done !
- ▶ Colour : grey
- ▶ Drilling  $\varnothing 8$  mm
- ▶ 100 % Nylon - Polyamide 6



**NEW**  
 $\varnothing 40$  &  $45$

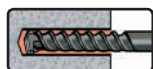
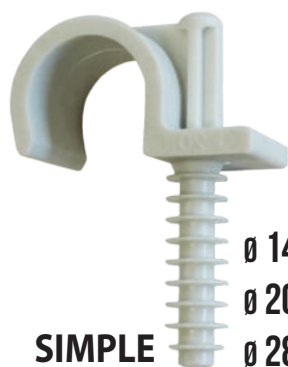

$\varnothing 8$  mm

$\varnothing 14 - 16 - 18$  MM

$\varnothing 20 - 22 - 25$  MM

$\varnothing 28 - 32$  MM

**SIMPLE**

FIX-RING®	Diameter (mm)	Quantity per box	Quantity of boxes per carton	Compatibility
Simple	14	100	16	
	16	100	16	WICU $\varnothing 10-12$
	18	100	16	Sheathed copper tube $\varnothing 12-14$ WICU $\varnothing 12-14$
	20	100	16	Sheathed copper tube $\varnothing 14-16$ WICU $\varnothing 14-16$
	22	100	16	PER $\varnothing 12$ WICU $\varnothing 16-18$ Sheathed copper tube $\varnothing 16-18$
	25	100	12	PER $\varnothing 16$
	28	100	12	PER $\varnothing 20$
	32	50	16	Sheath $\varnothing 32$

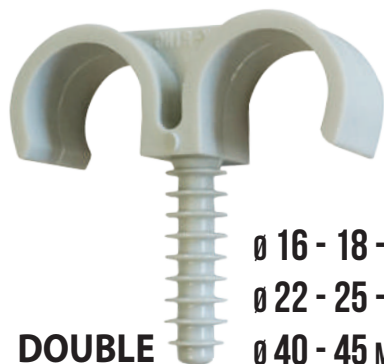

$\varnothing 16 - 18 - 20$  MM

$\varnothing 22 - 25 - 28$  MM

$\varnothing 40 - 45$  MM

**DOUBLE**



FIX-RING®	Diameter (mm)	Quantity per box	Quantity of boxes per carton	Compatibility
Double	16	100	16	WICU $\varnothing 10-12$
	18	100	12	Sheathed copper tube $\varnothing 12-14$ WICU $\varnothing 12-14$
	20	100	12	Sheathed copper tube $\varnothing 14-16$ WICU $\varnothing 14-16$
	22	100	9	PER $\varnothing 12$ WICU $\varnothing 16-18$ Sheathed copper tube $\varnothing 16-18$
	25	100	9	PER $\varnothing 16$
	28	50	12	PER $\varnothing 20$
	40	20	12	Insulated multilayer $\varnothing 40$
	45	20	12	Insulated multilayer $\varnothing 45$

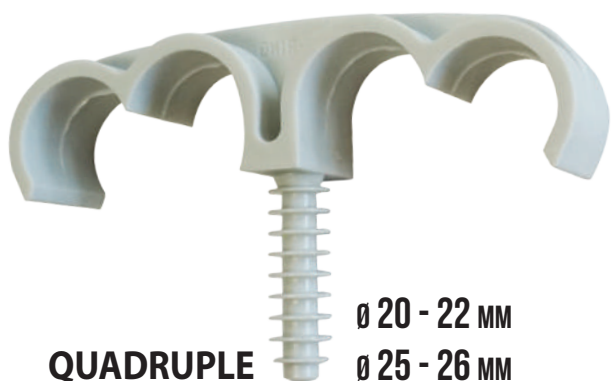

$\varnothing 20 - 22$  MM

$\varnothing 25 - 26$  MM

**QUADRUPLE**

FIX-RING®	Diameter (mm)	Quantity per box	Quantity of boxes per carton	Compatibility
Quadruple	20 - 22	50	12	Tubes to the collector
	25 - 26	50	9	

**CUSTOM'S CODE : 39269097**

# FIX-RING MULTI<sup>®</sup>

FOR FIXING MULTILAYER, PER TUBE, SHEATHED  
COPPER TUBE

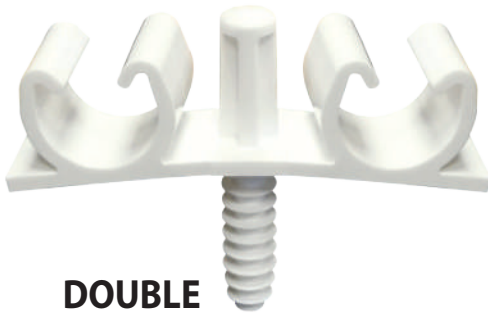
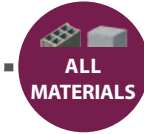

**DOUBLE**

Ø 16 - 20 mm

Ø 22 - 26 mm

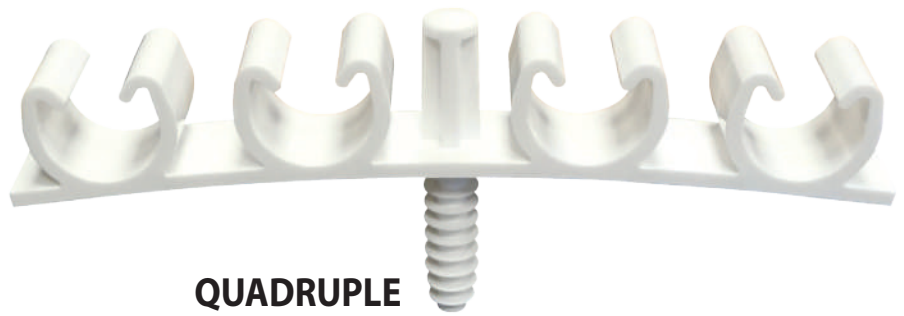

**QUADRUPLE**

Ø 16 - 20 mm

Ø 22 - 26 mm



Ø 16 to 20 : Ø 8 mm

Ø 22 to 26 : Ø 10 mm

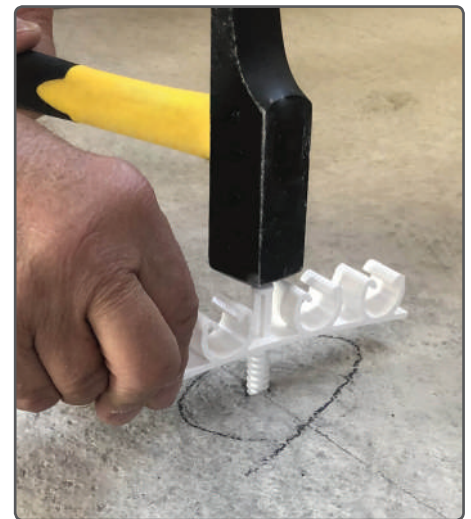

- ▶ Quick and easy : drill, hammer and clip tubing into place with your foot !
- ▶ Multi-diameter : one product for different diameters
- ▶ Safer work : fewer falls
- ▶ Reinforced strike zone
- ▶ Colour : white
- ▶ 100% nylon - Polyamide 6

**CUSTOM'S CODE : 39269097**

# TUB-RING® - THE ORIGINAL

**FIXING FOR MULTILAYER**



**SIMPLE**

Ø 15 - 16 MM  
 Ø 20 MM  
 Ø 25 - 26 MM  
 Ø 32 MM



**DOUBLE**

Ø 15 - 16 MM  
 Ø 20 MM  
 Ø 25 - 26 MM



**GOOD DISTANCE FROM THE WALL FOR THE PASSAGE OF INSULATION**



**USING THE CRIMPING PLIERS WITHOUT DISMANTLING THE TUBE**



«CLICK»

**SCREW, CLICK, IT'S FIXED !**

- ▶ Quick and easy : screw, click and done !
- ▶ Manually click into place
- ▶ Durable and secure : does not open
- ▶ Possible reopening with a screwdriver !
- ▶ Colour : white
- ▶ 100% nylon - Polyamide 6



**CUSTOM'S CODE : 39269097**

# FIX-RING CLIM<sup>®</sup>

FIXING FOR AIR-CONDITIONING UNITS

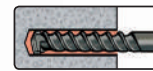
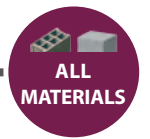
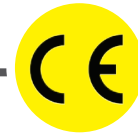

Ø 8 mm

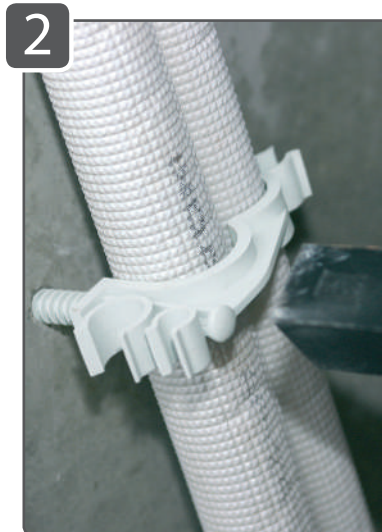
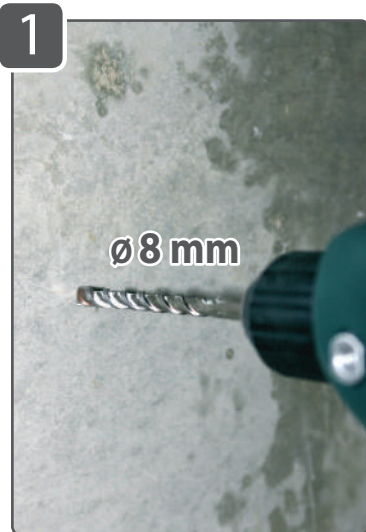

- ▶ Quick and easy : drill, hammer, done !
- ▶ Reinforced strike zone
- ▶ All materials
- ▶ Drill hole Ø 8 mm
- ▶ Colour : white
- ▶ 100% nylon - Polyamide 6

CUSTOM'S CODE : 39269097

# WALL PLUG FOR TAP

SOLUTION SYSTEM TO FIX YOUR TAPS IN THE BRICK OR IN THE CONCRETE BLOCK



  
HOLLOW  
MATERIALS

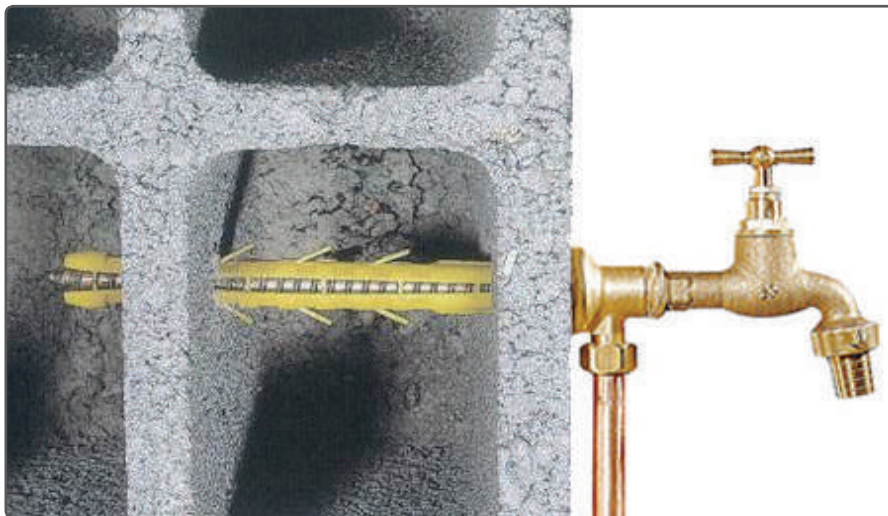
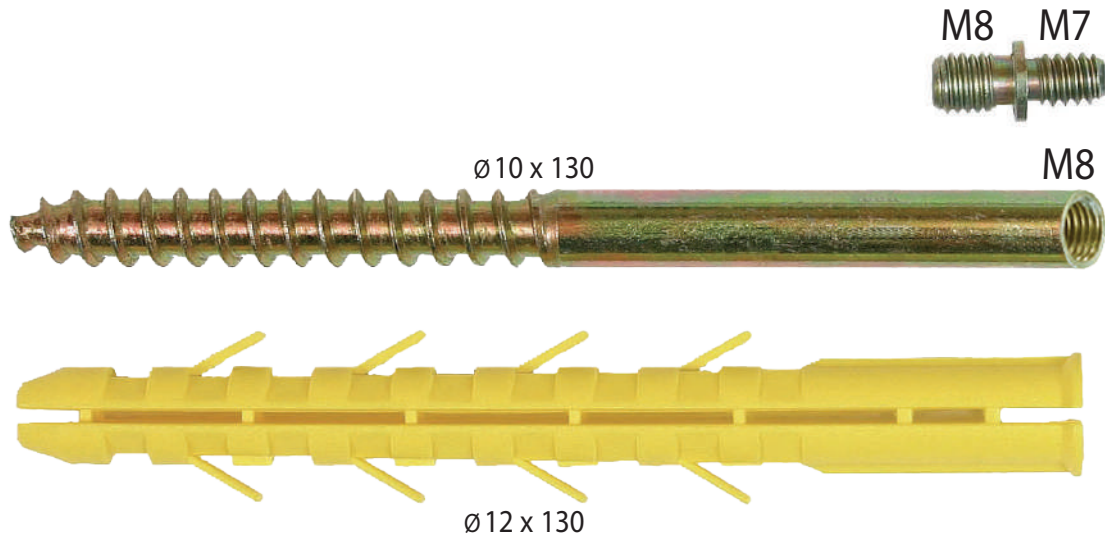

**WITHOUT INSULATION**

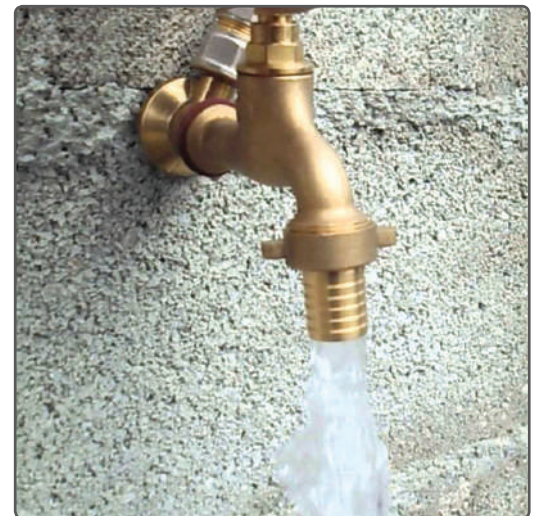

- ▶ Double-threaded screw with yellow zinc plating
- ▶ Nuts supplied
- ▶ Quick and easy !
- ▶ The plug expands into the concrete block cells
- ▶ Wall plug 100% nylon - Polyamide 6
- ▶ Anti-rotation lugs

CUSTOM'S CODE : 73181290

# WALL PLUG FOR TAP - WITH INSULATION

**SOLUTION SYSTEM TO FIX YOUR TAPS IN THE BRICK OR IN THE CONCRETE BLOCK WITH INSULATION**

  
HOLLOW  
MATERIALS

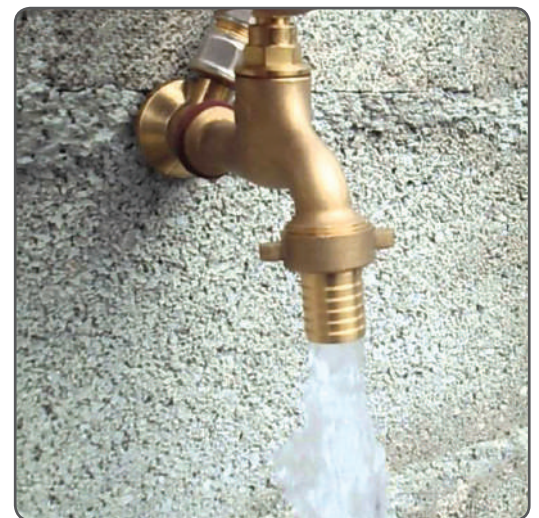
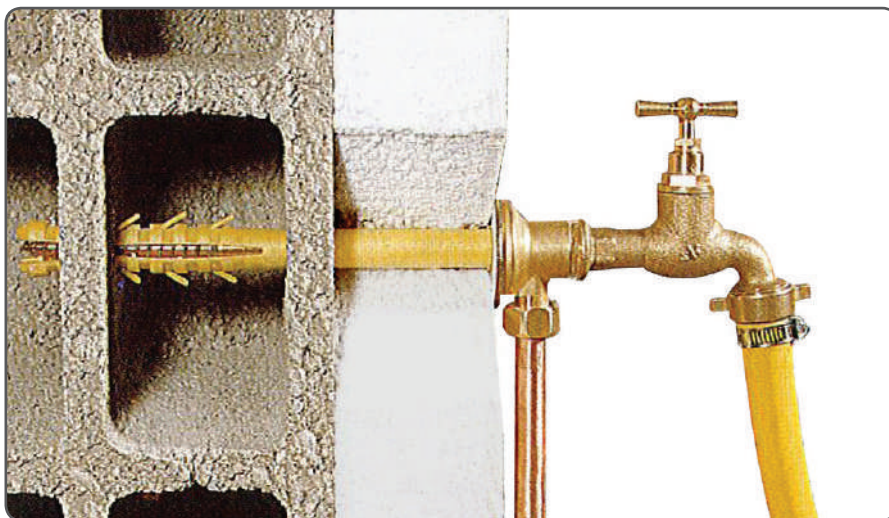

**WITH INSULATION**

- ▶ Double-threaded screw with yellow zinc plating
- ▶ Nuts and washers supplied
- ▶ Quick and easy !
- ▶ The plug expands into the concrete block cells
- ▶ Wall plug 100% nylon - Polyamide 6
- ▶ Anti-rotation lugs

Ø x L (mm)	Insulation maxi (mm)
Ø 16 x 200	70
Ø 16 x 240	110
Ø 16 x 300	170

**CUSTOM'S CODE : 73181290**

# WALL PLUG FOR WATER HEATING SYSTEM

FIXING FOR WATER HEATING SYSTEMS WITHOUT INSULATION



WELDED WASHER  
DOES NOT PASS BEHIND THE FIXING  
OF THE WATER HEATER

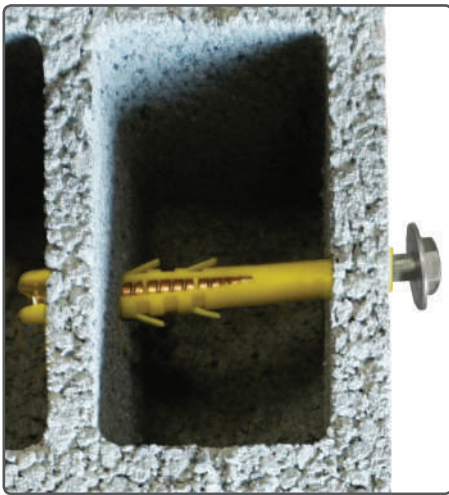
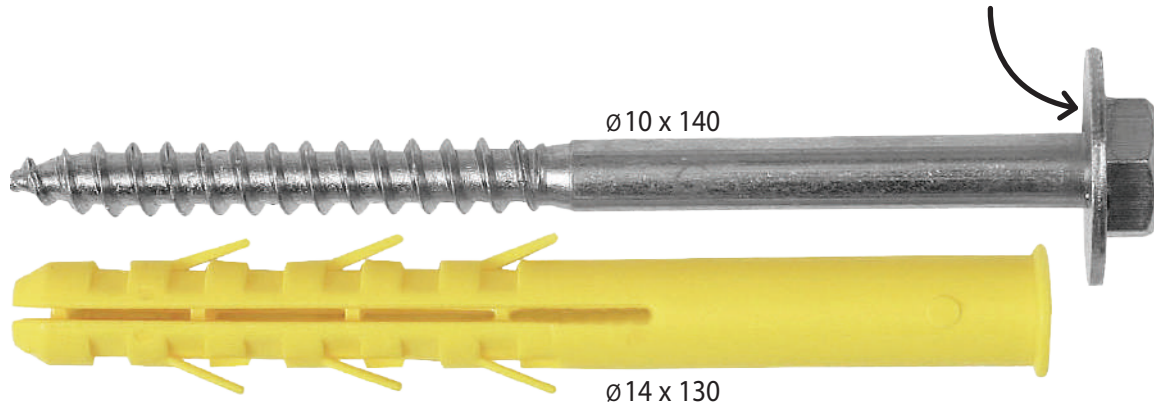

- ▶ Advice for use : tilt the fixing for greater resistance
- ▶ Drill hole  $\varnothing 14$
- ▶ Welded washer : the washer does not go behind the foot of the water heating system
- ▶ The plug expands into the concrete block cells
- ▶ Wall plug 100% nylon - Polyamide 6

CUSTOM'S CODE : 73181100

# WALL PLUG FOR WATER HEATING SYSTEM



FIXING FOR WATER HEATING SYSTEMS IN HOLLOW MATERIALS WITH LINING : INSULATION + PLASTERBOARD

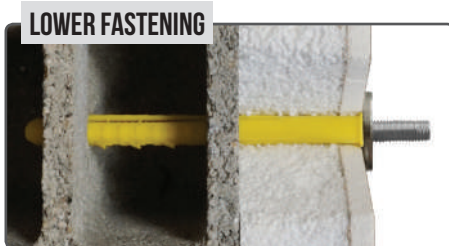
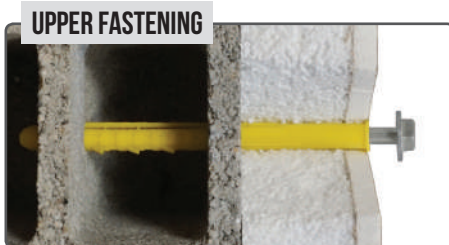
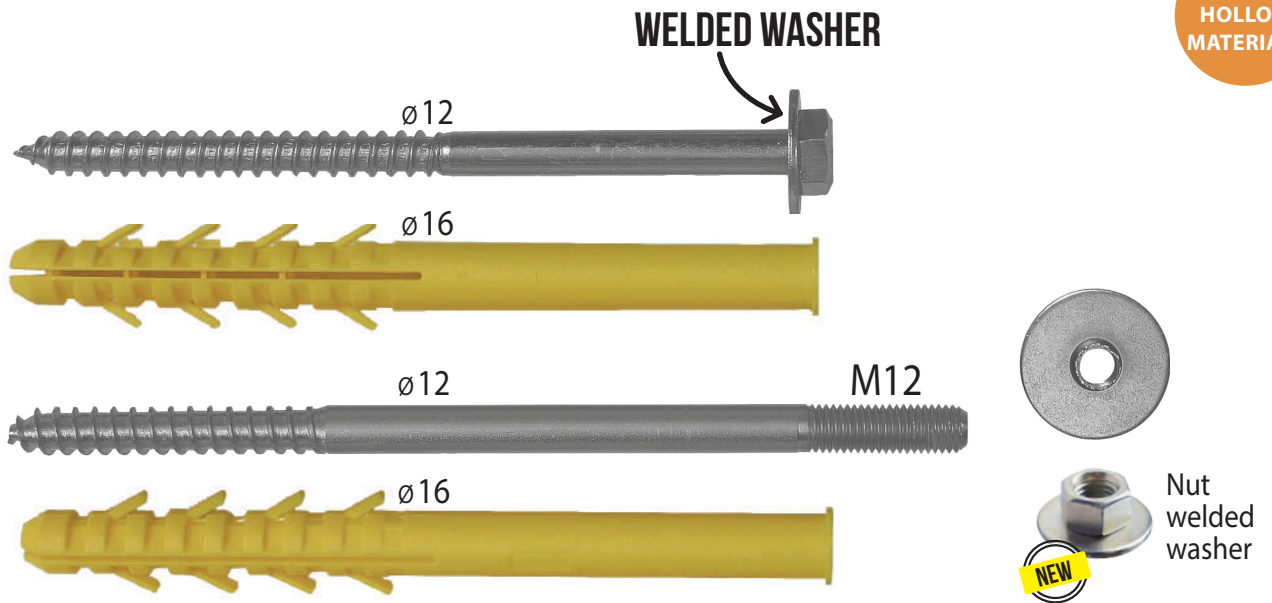

- ▶ Advice for use : tilt the fixing for greater resistance
- ▶ \* NEW : hexagonal recess for easy screwing
- ▶ Welded washer : the washer does not go behind the foot of the water heating system
- ▶ The plug expands into the concrete block cells
- ▶ Wall plug 100% nylon - Polyamide 6

Ø x L (mm)	Insulation maxi (mm)
Ø 16 x 200	70
Ø 16 x 240	110
Ø 16 x 300	170

CUSTOM'S CODE : 73181100



# M6-M8 UNIVERSAL FIXING



## WITHOUT INSULATION

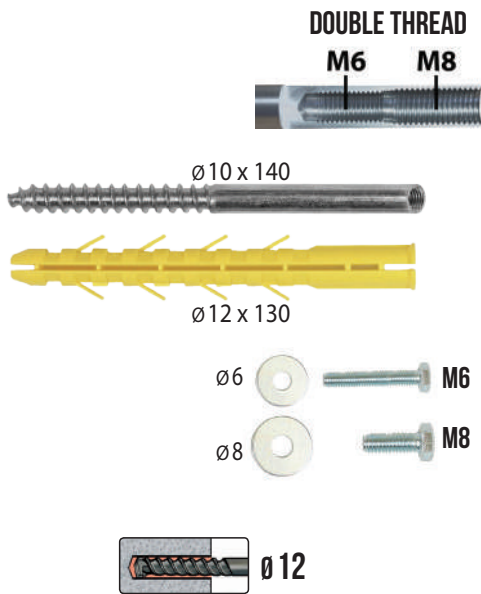

## INSULATION + PLASTERBOARD

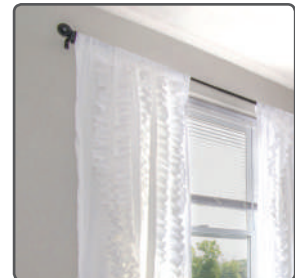
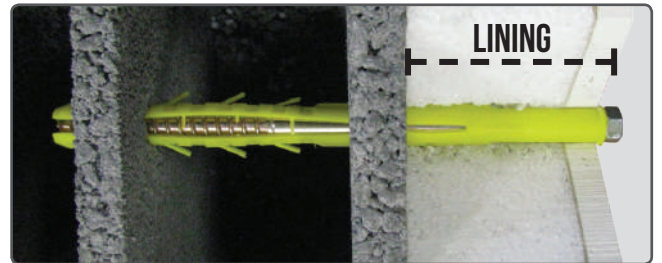
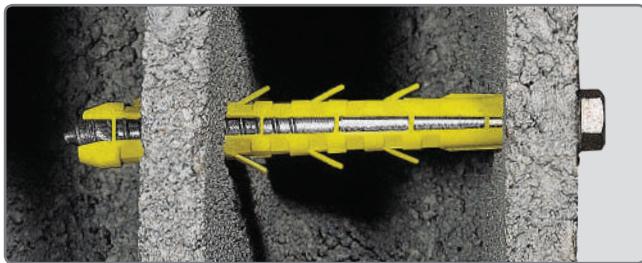
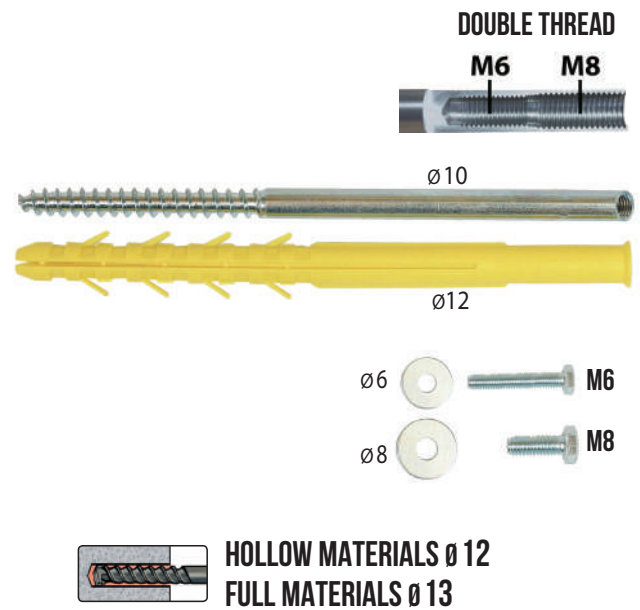

- ▶ Wall plug 100% nylon - Polyamide 6
- ▶ Anti-rotation
- ▶ Maximum thickness of the part to be fixed : 3 mm

CUSTOM'S CODE : 73181290

# CAST IRON RADIATOR WALL BRACKET

FASTENING CAST IRON RADITORS WITH  
INSULATION BACKING + DRYWALL

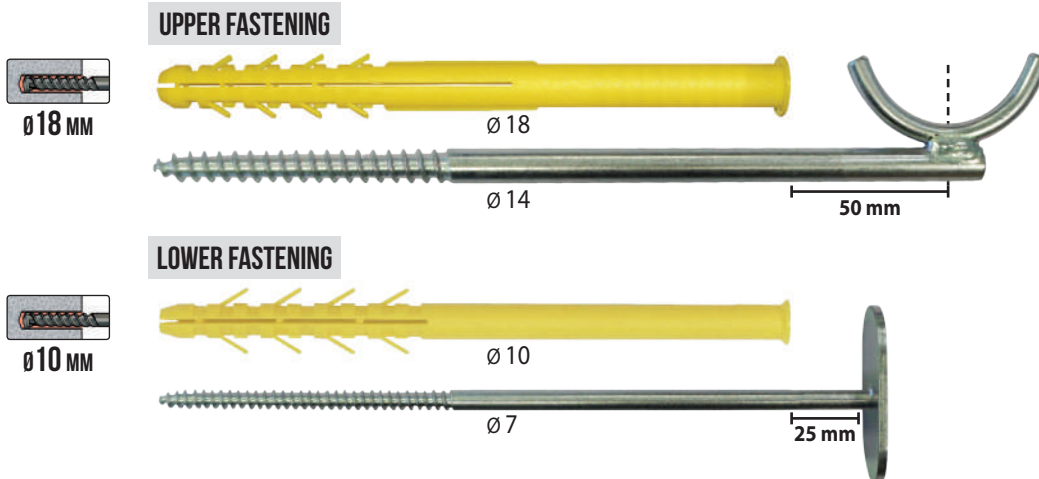

COMPLETE  
KIT

KG  
ROBUST

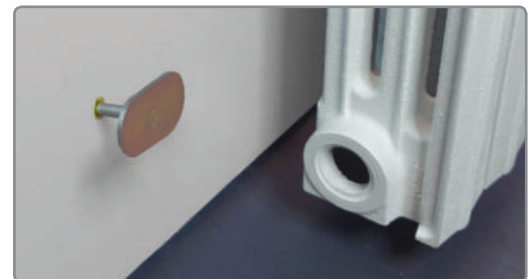
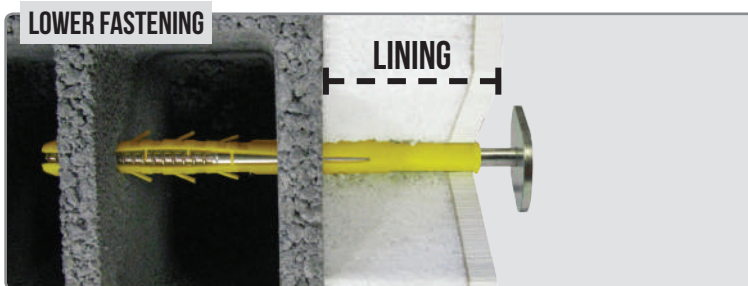
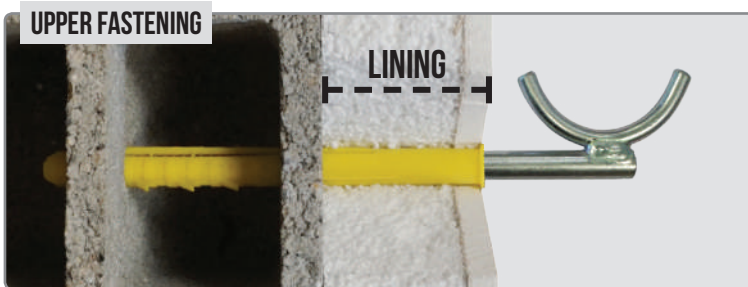

## APPLICATION



## CHARACTERISTICS

- ▶ For old walls or walls with lining
- ▶ Expansion over several cells of the concrete block or brick : **strong hold !**

CUSTOM'S CODE : 73269098

# ADJUSTABLE CONSOLE FOR FIXING COLLECTIVE WASH BASIN



## STANDARD & LARGE

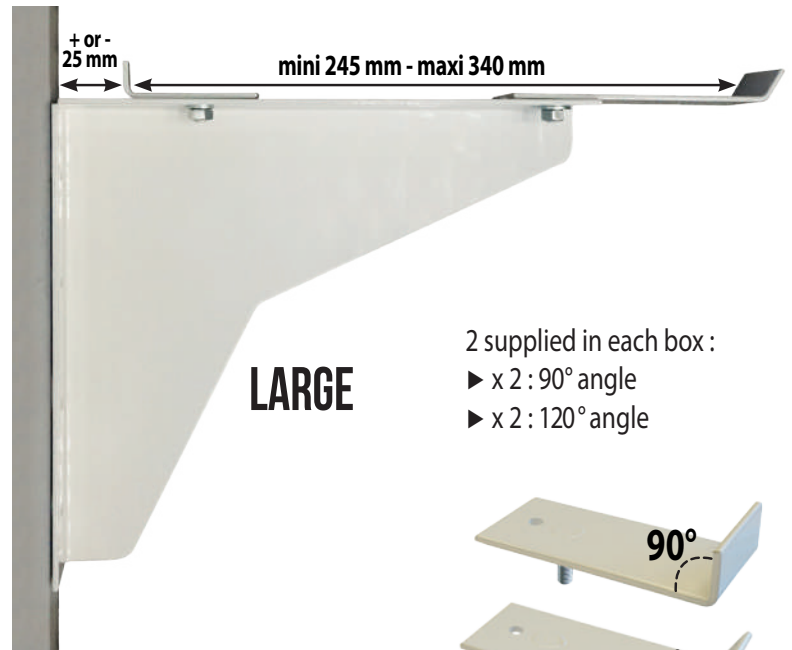

2 supplied in each box :

- ▶ x 2 : 90° angle
- ▶ x 2 : 120° angle

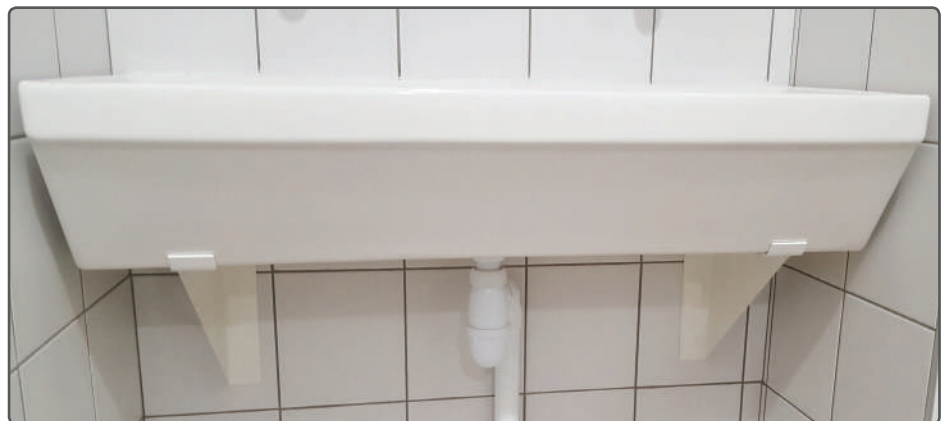
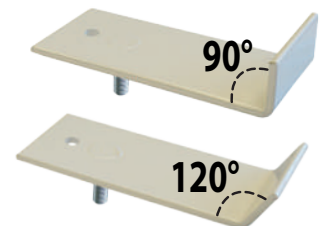

- ▶ Coated in white epoxy paint
- ▶ Adapt the fixing depending on the substrate
- ▶ Adapts to any collective wash basin
- ▶ Adjustable length :
  - Standard sink brackets : **180 mm to 255 mm**
  - Long sink brackets : **245 mm to 340 mm**
- ▶ Each box contains : **2 x 90°** corner brackets, **2 x 120°** corner brackets

**CUSTOM'S CODE : 72169180**

# WELDED AIR-CONDITIONING BRACKET

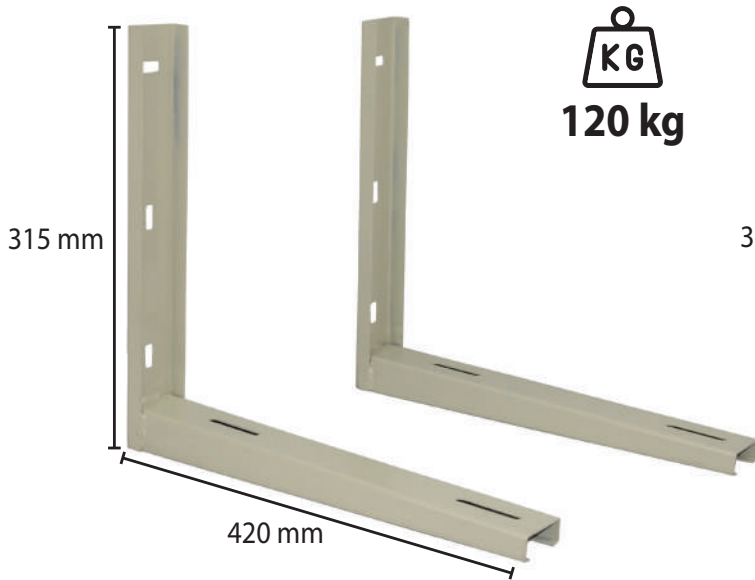

**KG**  
**120 kg**

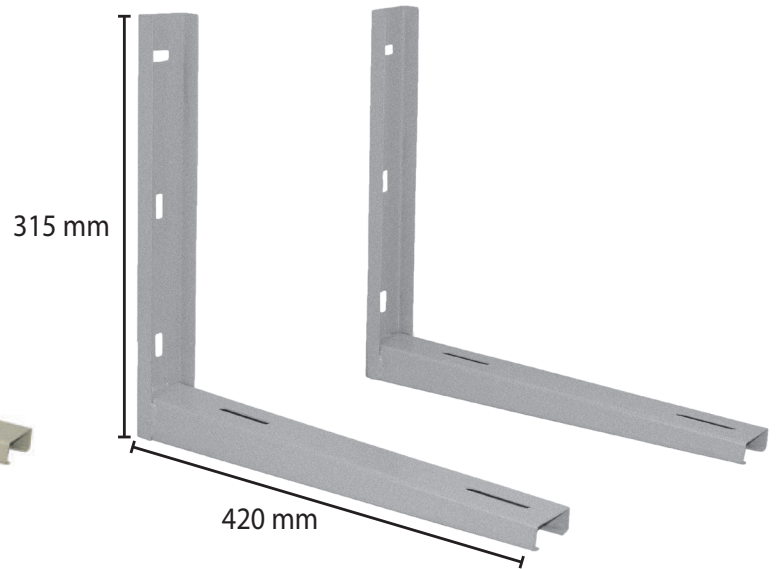

**PPC FINISH - WHITE RAL9003**  
corrosion resistant

**GALVANIZED FINISH**  
corrosion resistant



**SILENTBLOCS**  
to prevent vibration noise  
ALSO AVAILABLE

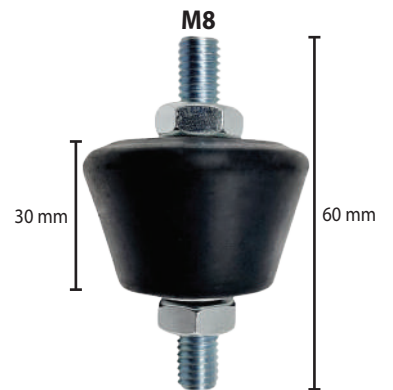

## AIR-CONDITIONING SUPPORT FIXINGS

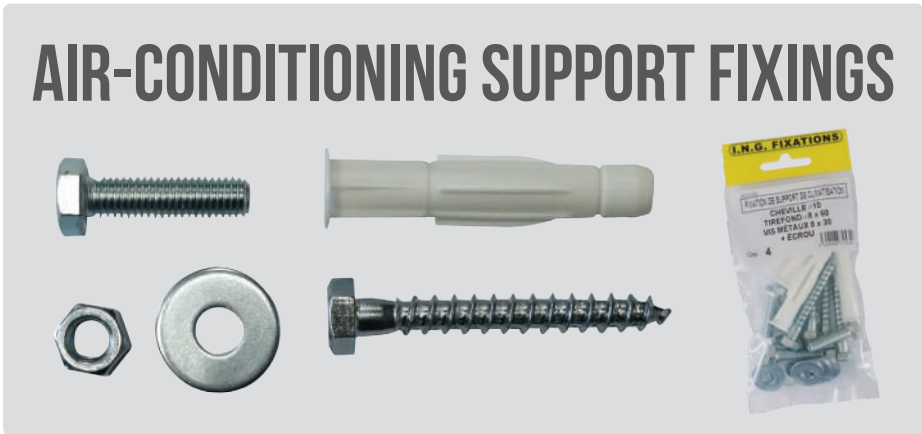

**CUSTOM'S CODE : 721691800**

# IZY<sup>®</sup> 7-8-10

SCREWING TOOL FOR THREADED ROD

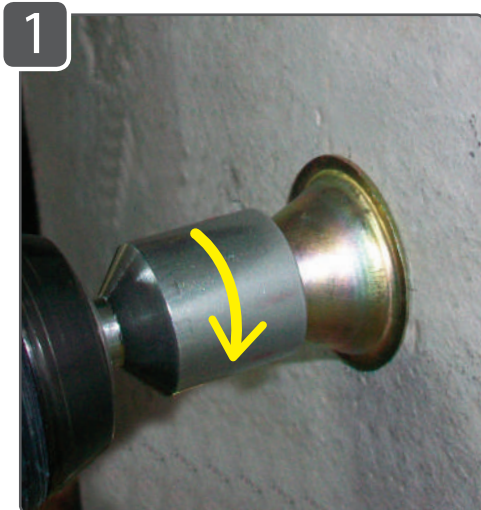
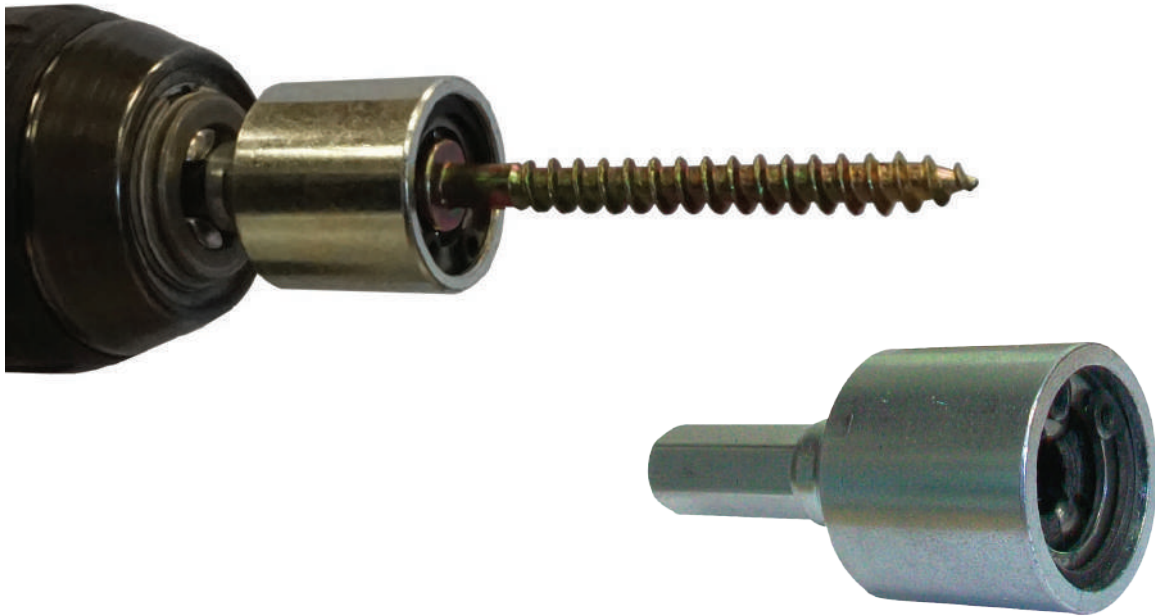

SCREW SLOWLY



STOP IN TIME

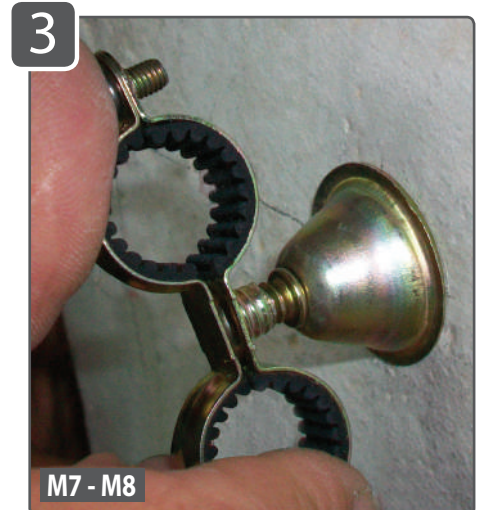

UNSCREWING POSSIBLE

- ▶ Allow screwing and unscrewing (in renovation)
- ▶ Time savings
- ▶ Facilitates the installation of double thread screw
- ▶ Does not damage the screw thread
- ▶ The double thread screws grips the tool itself



CUSTOM'S CODE : 82055980

# CONNECTION SCREW M10

FOR THE CONTINUATION OF M10 THREADED ROD



**KG**  
**150 KG**  
WEIGHTED LOAD  
WITH A SAFETY  
FACTOR OF 3

Ideal for the installation of  
an automatic extinguishing  
like a «Sprinkler»

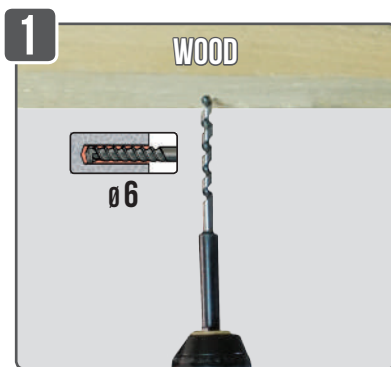
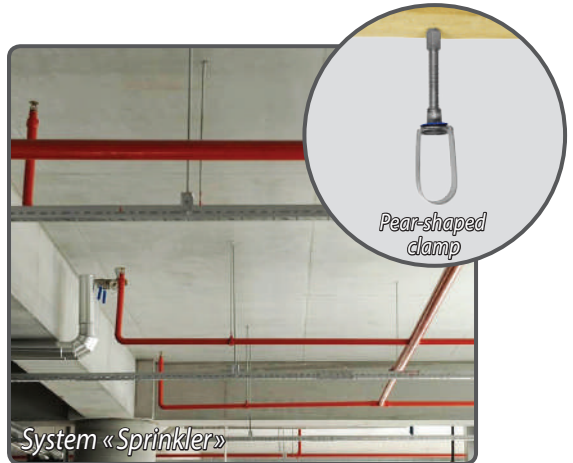

Pre-drill Ø6

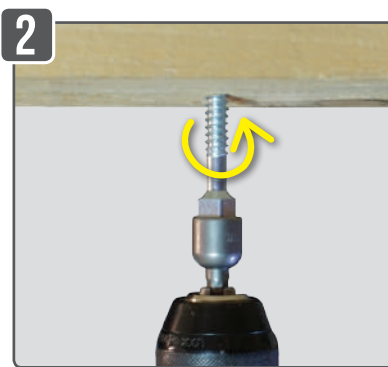

Screw in using a 12 mm socket

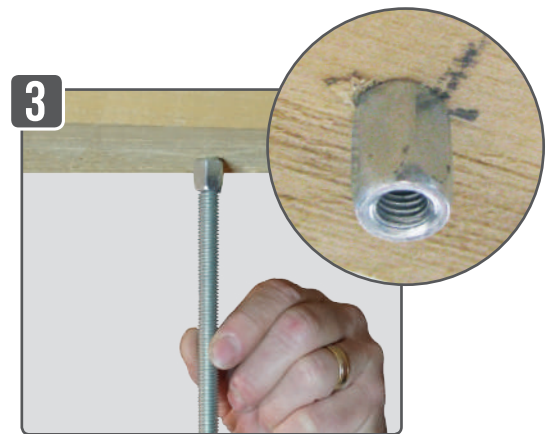

Install the M10 threaded rod

CUSTOM'S CODE : 73181290

# CONNECTOR ANGLED M7 & M8



ALLOWS TO POSITION THE VERTICAL PIPES

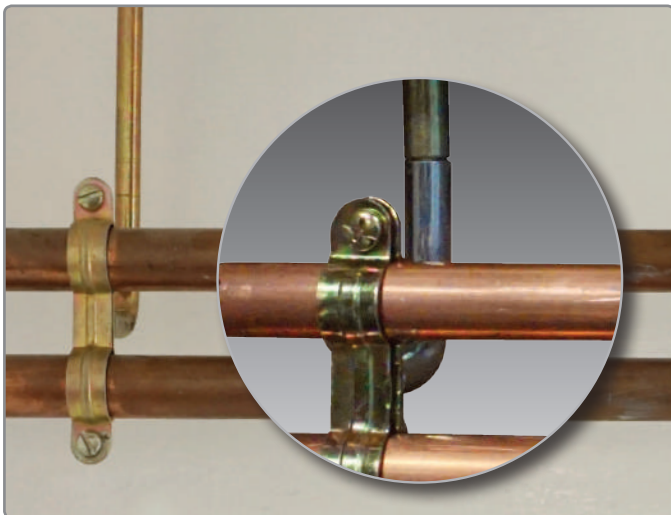
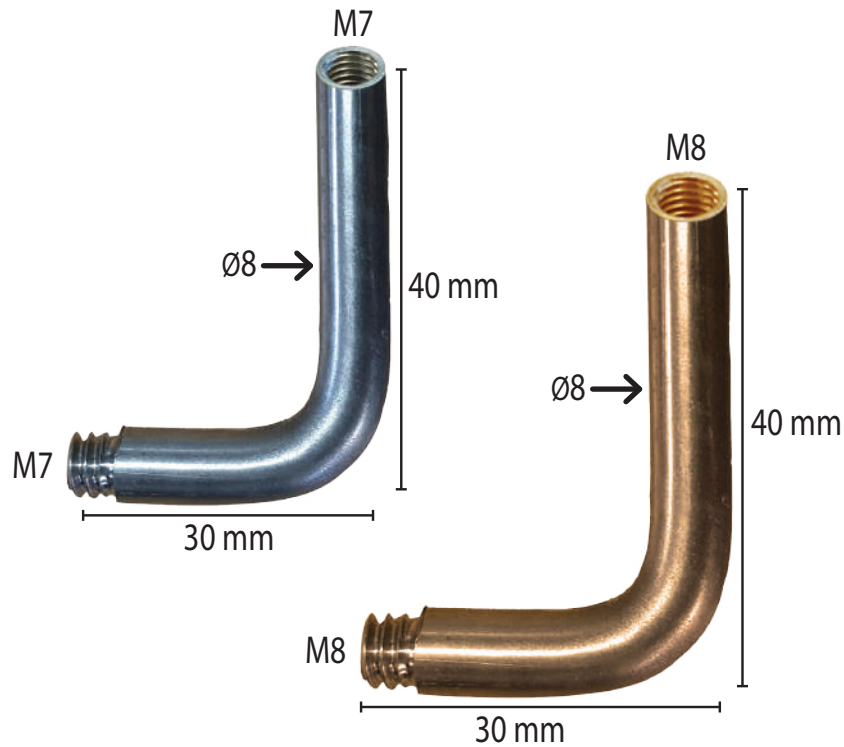

- ▶ Height **40 mm** x width **30 mm**
- ▶ **Ø8 mm**
- ▶ Available with yellow or white zinc plating
- ▶ Enables pipes to be positioned upright
- ▶ Allow the creation of the branching

CUSTOM'S CODE : 73079290

# JUNCTION FITTING



## COMPLETE RANGE

### MALE - MALE

Thread	Conditioning	Finish
Male M6 - Male M7	Bag of 10	Yellow zinc plated
	Box of 100	



Thread	Conditioning	Finish
Male M6 - Male M8	Bag of 10	Yellow zinc plated
	Box of 100	



Thread	Conditioning	Finish
Male M7 - Male M7	Bag of 10	Yellow zinc plated
	Box of 100	



Thread	Conditioning	Finish
Male M7 - Male M8	Bag of 10	Yellow zinc plated
	Box of 100	



Thread	Conditioning	Finish
Male M8 - Male M8	Bag of 10	Yellow zinc plated
	Box of 100	



### MALE - FEMALE Ø 10

Thread	Conditioning	Finish
Male M7 - Female M6	Bag of 10	White zinc plated
	Box of 100	



Thread	Conditioning	Finish
Male M7 - Female M8	Bag of 10	Yellow zinc plated
	Box of 100	



Thread	Conditioning	Finish
Male M7 - Female M8	Bag of 10	White zinc plated
	Box of 100	



Thread	Conditioning	Finish
Male M8 - Female M7	Bag of 10	White zinc plated
	Box of 100	



Thread	Cond	Finish
Male - Female length 15 mm	Bag of 10	White zinc plated
	Box of 100	



### MALE - FEMALE Ø 12



Thread	Conditioning	Finish
Male M7 - Female M7	Box of 100	White zinc plated

Thread	Conditioning	Finish
Male M8 - Female M8	Box of 100	White zinc plated

### EXTENSION FOR CLAMPS



Thread	Conditioning	Finish
Male M10 - Female M7	Box of 50	White zinc plated

Thread	Conditioning	Finish
Male M10 - Female M8	Box of 50	White zinc plated

CUSTOM'S CODE : 73181900



# M6 QUICK-FIX WASHER + CAVITY TOGGLE



FOR MOUNTING DRAINAGE PIPES

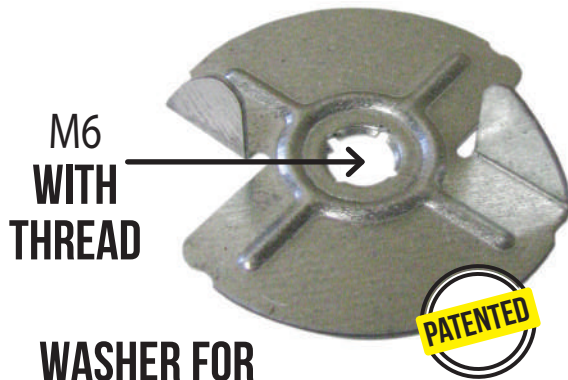

WASHER FOR  
CAVITY TOGGLE

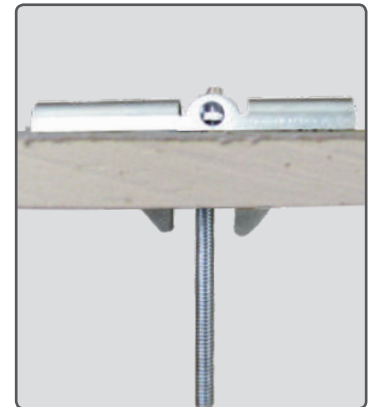
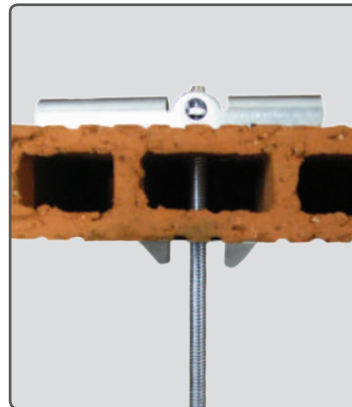
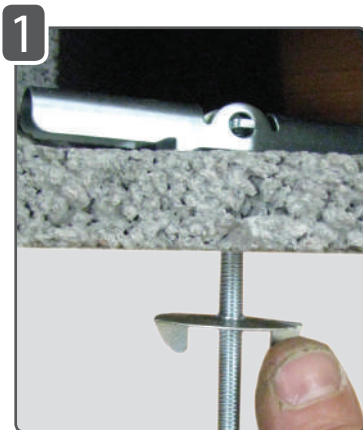
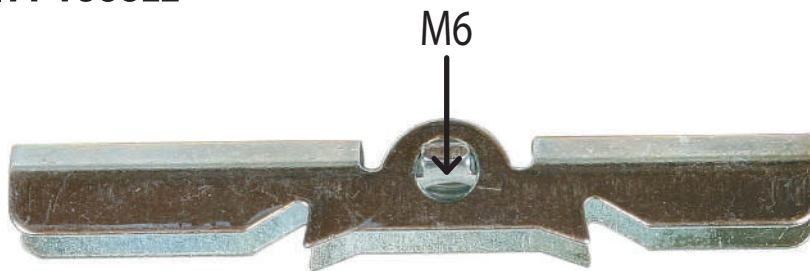

- ▶ Use on slabs, brick and plasterboard
- ▶ Fixing details :
  - M6 toggle bolts
  - M6 quick-fix nut
  - Male M7/female M6 pipe nipple fittings

CUSTOM'S CODE : 73269098

# CLAMP - PIPE FIXING ON THREADED-ROD M6, M7 & M8



**Ø 32 & 40**  
TIGHTENING 30 TO 34      TIGHTENING 38 TO 42



- ▶ Fast fixing direct threaded rod
- ▶ Resistant -40°C to 70°C

CUSTOM'S CODE : 39174000

# RAPIDO®

SUSPENSION SYSTEM DIRECTLY INTO CONCRETE



**NO PLUGS !**



M6  
M7  
M8

**KG**  
100 kg\*

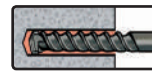

ø 6 mm

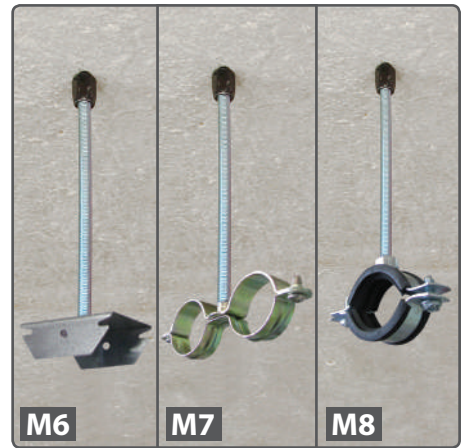
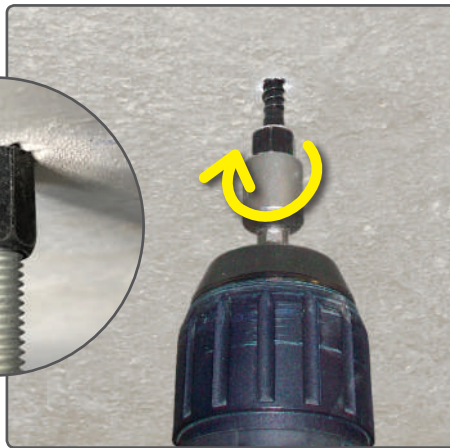

SCREWDRIVER SETTINGS : SLOW SPEED AND HIGH TORQUE

- ▶ Reduced drilling diameter : time savings
- ▶ Setting tool : hex socket, **10 mm**
- ▶ Driver adjustment : high torque/slow speed
- ▶ Not to be used with an impact wrench
- ▶ \* Permissible load : **100 kg** (factored load with a safety coefficient of 3)
- ▶ Uses : plasterboard ceilings, light fittings, cable trays, suspended ceilings, sanitary pipe clamps, heavy-duty pipe clamps, air-conditioning units, mechanical controlled ventilation etc...

CUSTOM'S CODE : 73181290

# SPEEDY-FIX®

HANGER FOR USE DIRECTLY IN CONCRETE



**NO PLUGS !**



**KG**  
**100 kg\***  
weighted load

  
**ø 5 mm**



- ▶ Setting tool supplied
- ▶ Drill hole **ø 5 mm**
- ▶ Driver adjustment : high torque/low speed
- ▶ Not to be used with an impact wrench
- ▶ \* Permissible load : **100 kg** (factored load with a safety coefficient of 3)
- ▶ Thread length : **32 mm**
- ▶ Eyelet diameter : **5,5 mm**
- ▶ Can be used to suspend chains, steel wires, hooks, carabiners, cables, unthreaded rods, cable trays etc...

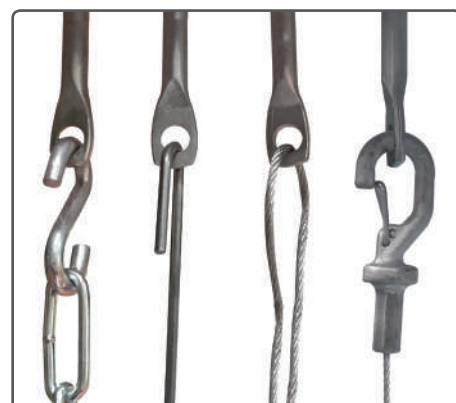

**CUSTOM'S CODE : 73181290**

# FIX-FOURRURE

FOR INSTALLATION ON STORE OR BRICK WALLS

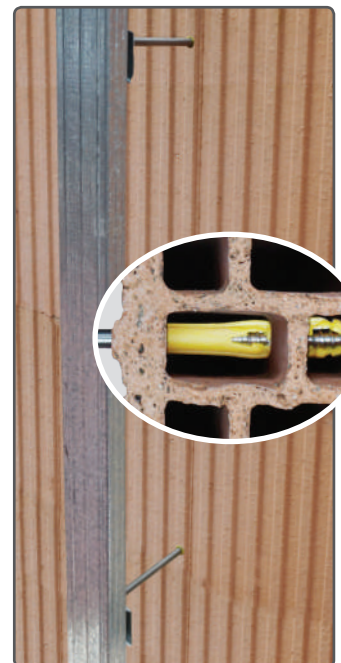
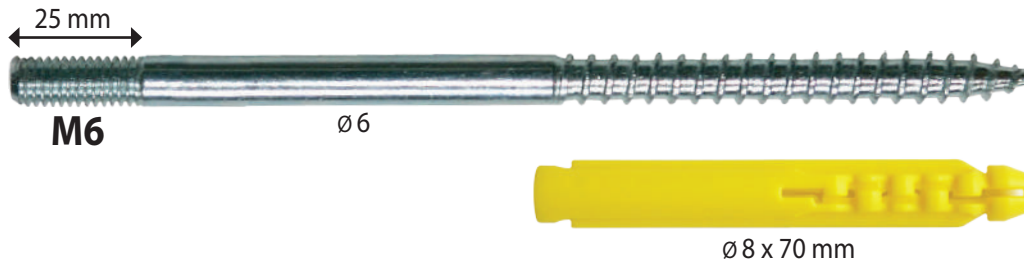
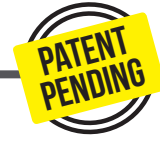

- ▶ Easy and quick : avoids the need to fix a horizontal furring strip to the wall
- ▶ One simple Ø 8 mm drilling = always level
- ▶ Effectively replaces intermediate supports



## ALSO USABLE FOR DROP CEILINGS

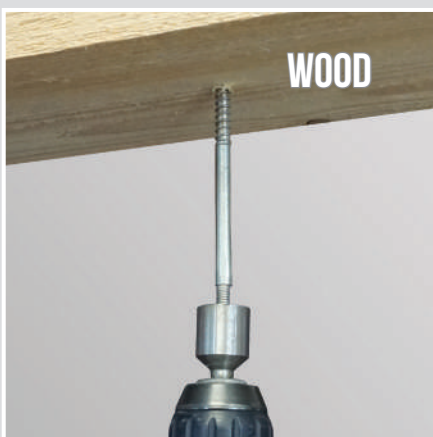

CUSTOM'S CODE : 73181595

# FIX-ASPHALT®



## REMOVABLE RESIN FIXING FOR ASPHALT



PLUG TO PROTECT  
THE THREAD



Allows you to hang  
cartridges on pins

**MP<sup>MAX</sup> RESIN**

**VINYLESTER RESIN  
STYRENE-FREE**

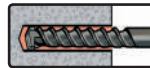

M8 : Ø 12 mm  
M10 : Ø 14 mm  
M12 : Ø 16 mm

Threading	Ø x L (mm)
M8	10 x 70
M10	12 x 70
	12 x 100
	14 x 100
M12	14 x 70
	14 x 100



- ▶ Female double-threaded screw
- ▶ Available in M8, M10 and M12 - lengths : **70 mm** and **100 mm**
- ▶ For use with our MP<sup>MAX</sup> resin
- ▶ Screw length : thickness to be anchored + **15 mm**
- ▶ Uses : removable Parking barriers, retarders, bollards, shelters, road signs, signage indicating underground networks, playgrounds, gate operating systems etc...



CUSTOM'S CODE : 73181900

# A4 STAINLESS STEEL RESIN SOCKET

FOR HUMID AND CORROSIVE ENVIRONMENTS



PLUG TO PROTECT  
THE THREAD



MANUFACTURED IN OUR  
FACTORIES : VARIOUS  
POSSIBILITIES, CONSULT US!



VERY HIGH  
QUALITY



Ø REDUCED DRILLING DIAMETER

M8 : ø 12  
M10 : ø 14

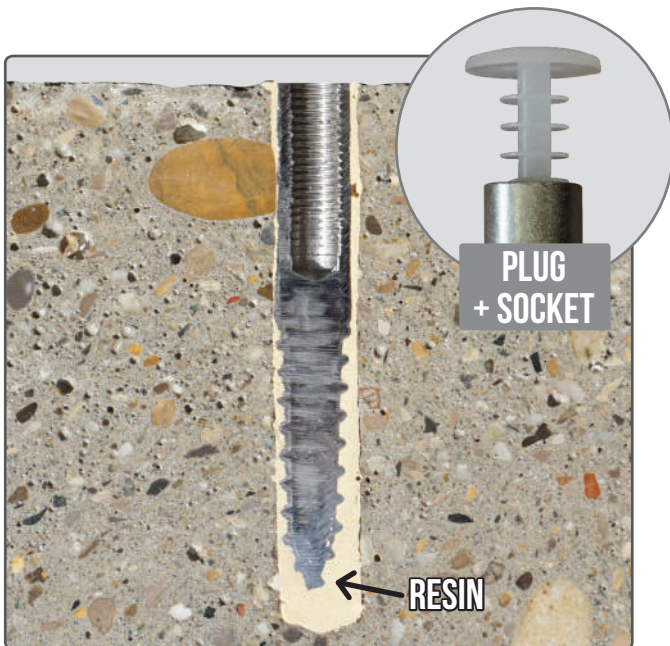

## APPLICATIONS

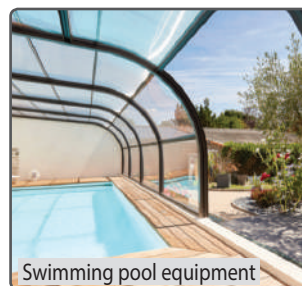

CUSTOM'S CODE : 73181900

# FIX-STORE<sup>®</sup>



## RESINE ANCHOR FOR HOLLOW MATERIALS

**+ POSSIBILITY WITH INSULATION !**

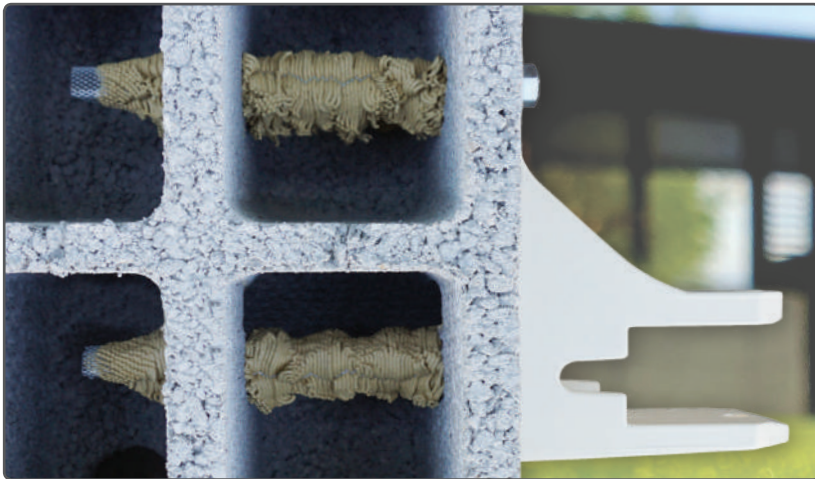
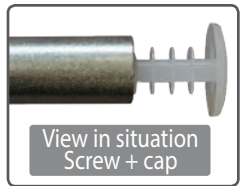
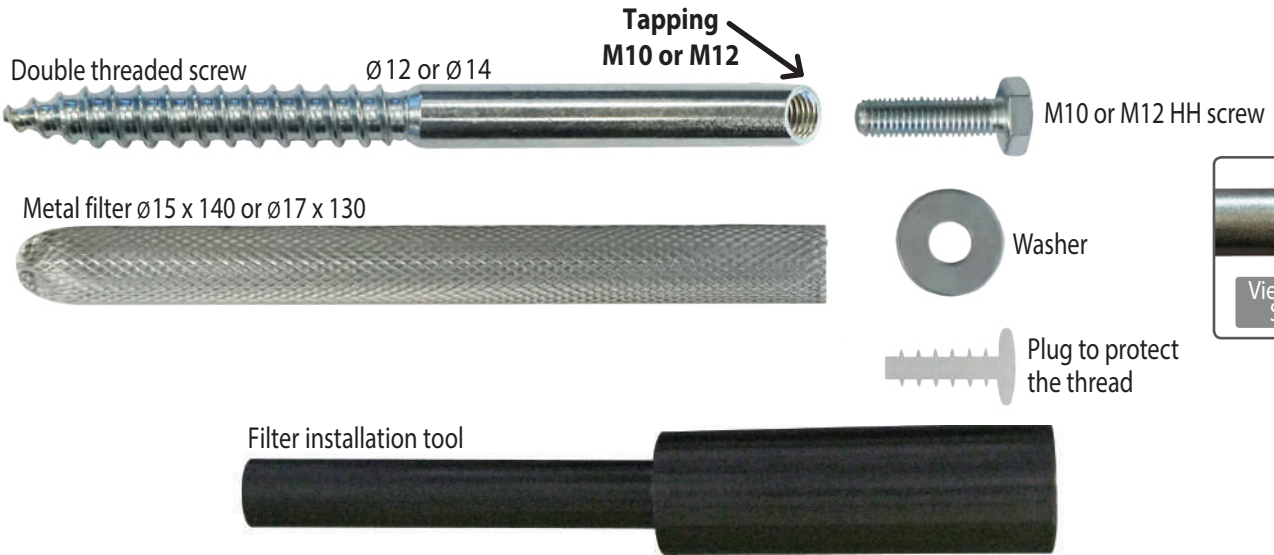

- ▶ Steel and stainless-steel finishes
- ▶ Female double-threaded screw
- ▶ Contents : female double-threaded screw + hex head screw + metal resin injection anchor sleeve + washer + cap to protect the threading + setting tool for the resin injection anchor sleeve
- ▶ Anchoring across several cells in the concrete block
- ▶ Removable
- ▶ Uses : heavy fixings in hollow materials : awnings, verandas, barriers, guardrails, satellite dishes etc...



CUSTOM'S CODE : 73181290



# ISOL-FIX<sup>®</sup>

## FIXING FOR CAVITY DRAIN MEMBRANE

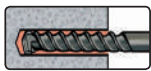

Ø 6 mm

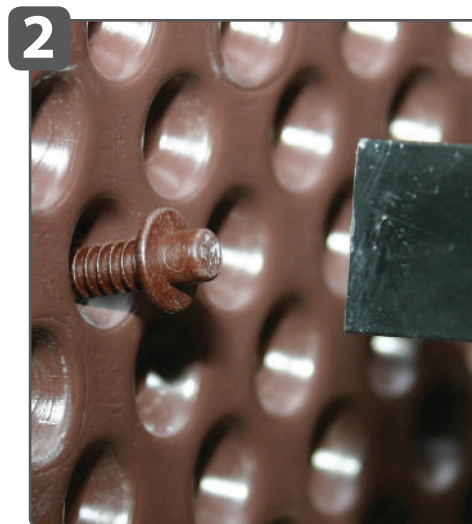
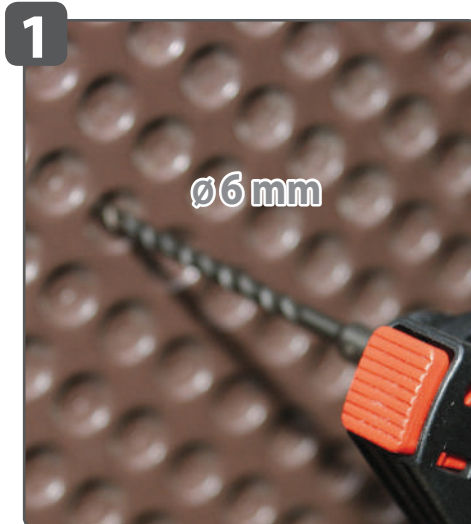

- ▶ Quick and easy : drill, hammer, done !
- ▶ Preserves the impermeability of cavity drain membrane
- ▶ One advantage is that it replaces steel studs : less waste and better hold over time (no corrosion)
- ▶ 100% nylon - Polyamide 6
- ▶ Colour : brown
- ▶ Drill hole **Ø6 mm**



CUSTOM'S CODE : 39269097

# PRATICO<sup>®</sup> - MAGNETIC TOOL

MULTI-FUNCTION TOOL

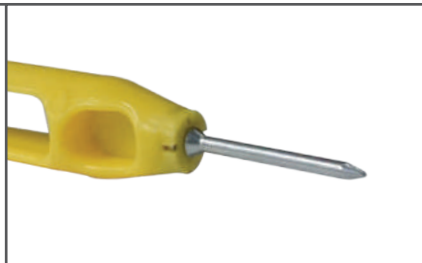

- ▶ Easy installation !
- ▶ Multiple applications : sheet metal edge clips, metallic wall plugs, screws, nuts, steel nails etc...
- ▶ Colour : yellow

CUSTOM'S CODE : 82055980

# POLYAMIDE THROUGH PLUG

  
ALL  
MATERIALS



Ø8 x 68



INDICATIVE LOAD  
**50 kg**



**OPTIMAL  
EXPANSION**



Ø 8 mm

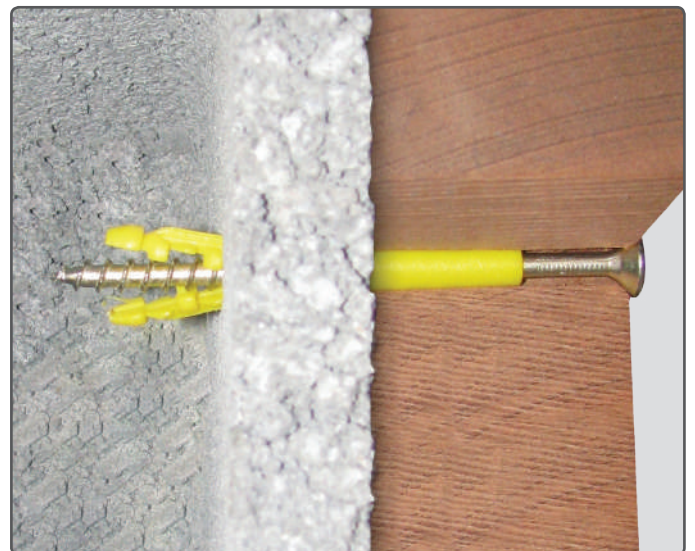
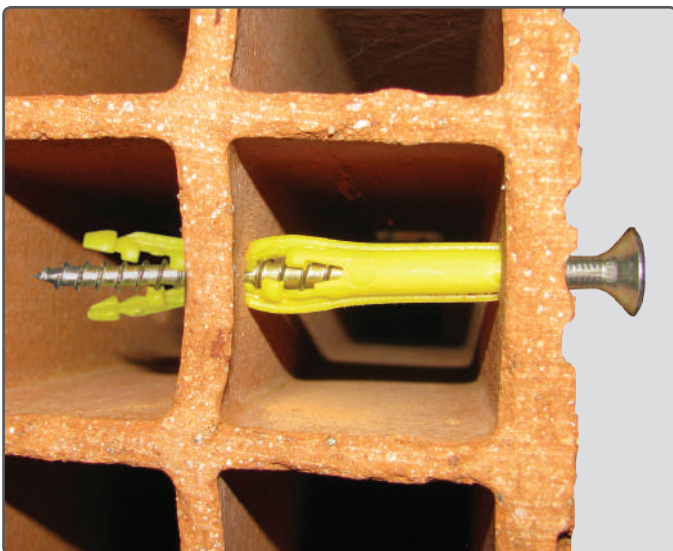

- ▶ Ideal for brick
- ▶ Optimal hold on the 2 cells of the red bricks
- ▶ Installation possible trough the part to be fixed
- ▶ Anti-rotation system

**CUSTOM'S CODE : 39269097**

# GUTTER FIXINGS

A SIMPLE IDEA THAT MAKES FIXING PIPES CLAMPS EASIER

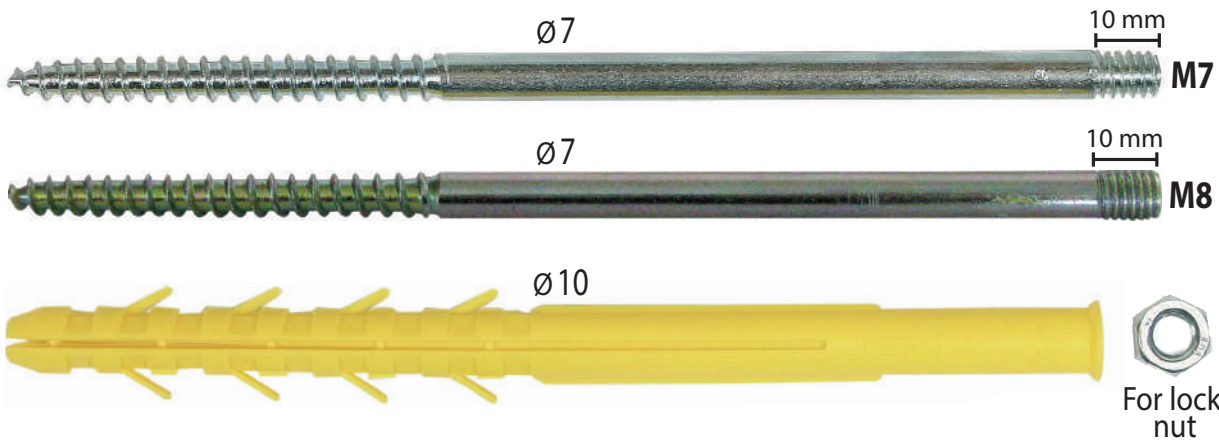

**New : 2 ways to screw :**  
- manually  
- with a screwdriver

 Manual **OR** 

**M7 & M8**

**LENGTHS : 170 - 210 - 250 - 290 - 350**

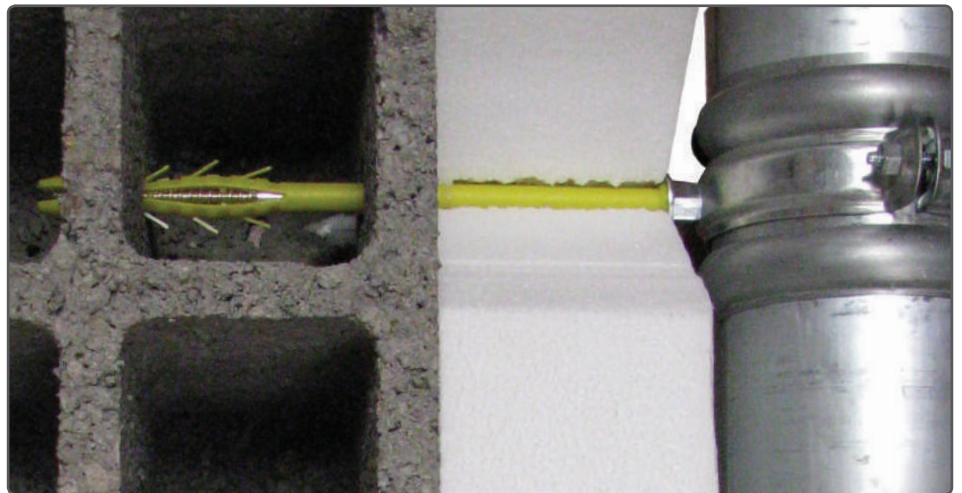

- ▶ Quick and easy
- ▶ The clamp is always at the correct distance
- ▶ All materials and ideal for hollow materials

**CUSTOM'S CODE : 73181300**

# EXTERNAL THERMAL INSULATION BLOCK

FOR OFFSETTING THE SHUTTER HINGES IN THE CONTEXT OF EXTERNAL INSULATION

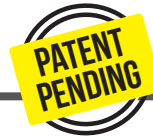

100% RECYCLED PRODUCT

FROM PLASTIC BOTTLE CAPS



**CSTB**

le futur en construction

Thermal transmission coefficient  $\lambda = 0,002$  W/K (CSTB test report available upon request) for ETI block with a length of 140 mm

120 - 140 - 160 mm

120 mm

60 mm

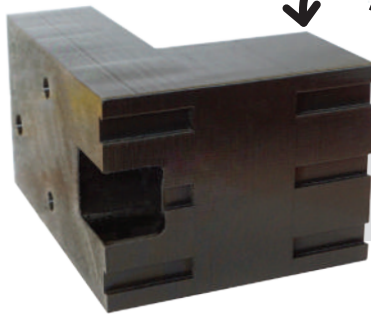

Notches for better adherence of external plaster

Location for receiving the lower part of the hinge

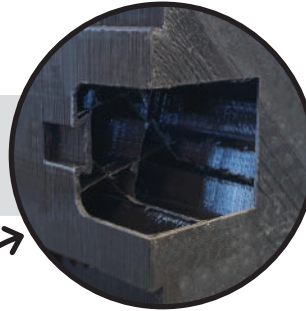

ADVANTAGE



Cut only the cotter

FASTENINGS INCLUDED

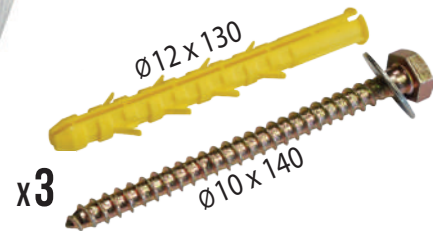

Ø 12 MM THROUGH THE BLOCK

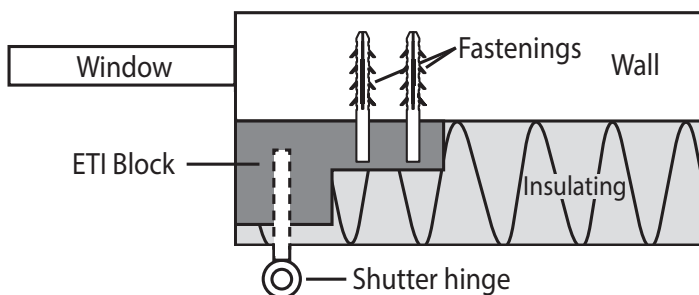

CUSTOM'S CODE : 392590 10

# FIX-GABION



**GALVANIZED  
FINISH**

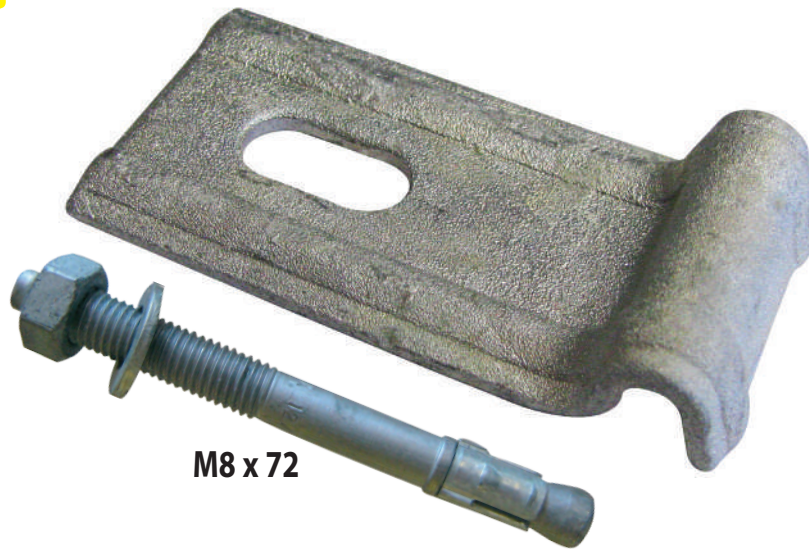

**M8 x 72**



**CUSTOM'S CODE : 73181290**

# SIGNAGE PANEL FIXING

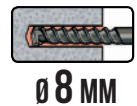

**GALVANIZED  
FINISH**

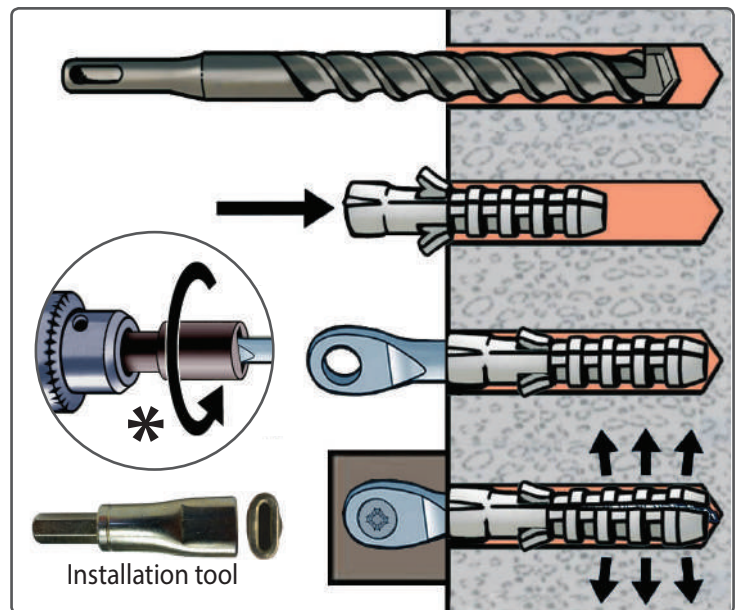
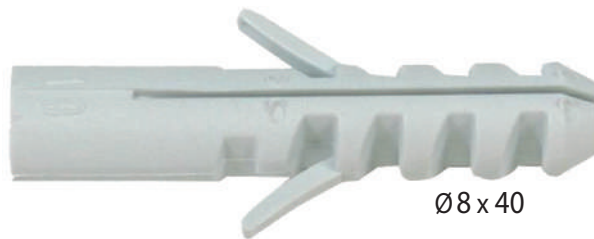

- ▶ Facilitates wall mounting of signage panels
- ▶ **Galvanized** finish
- ▶ Rust-free : corrosion-resistant
- ▶ \* 1 installation tool provided in the box : easy screwing !

CUSTOM'S CODE : 73181290

# A4 STAINLESS STEEL

FOR HUMID AND CORROSIVE ENVIRONMENTS



M8  
M10

ANTI-CORROSION



M8 :  $\varnothing$  12  
M10 :  $\varnothing$  14

## CHARACTERISTICS

- ▶ Fastening for thin concrete on stone : reduced anchoring depth
- ▶ Compatible with metric threaded screws and threaded rods
- ▶ Easy expansion by screwing (without installation tool)
- ▶ **High-quality A4 stainless steel** : ideal for humid and corrosive environments

## APPLICATIONS

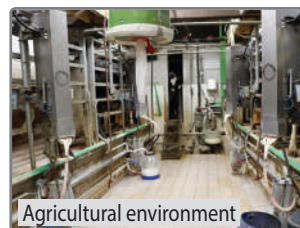
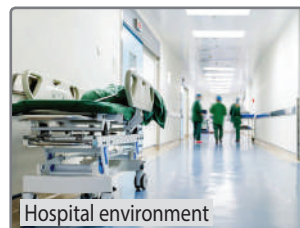
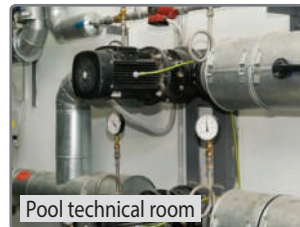

### Average indicative loads

 M8 : **150** kg    M10 : **250** kg

CUSTOM'S CODE : 83024190



# OUR PACKAGING



COMPLETE RANGE

A WIDE VARIETY OF PACKAGING TO MEET ALL YOUR NEEDS :  
BOXES, BAGS, BUCKETS, PLASTIC BLISTERS ...



Neutral boxes with personalized labels!

- SOLID MATERIALS
- HOLLOW MATERIALS
- I.N.G. FIXATIONS
- MULTI MATERIALS
- FASTENERS

DURABLE, STACKABLE, AND REUSABLE  
PLASTIC CONTAINERS FOR CRAFTSMEN





# I.N.G. FIXATIONS

FRENCH CREATOR AND MANUFACTURER *since 1985!*

## HEAD OFFICE AND PRODUCTION SITE

### I.N.G. FIXATIONS

Z.I. de Chassende  
43000 Le Puy-en-Velay  
France

EMAIL :

[ing@ingfixations.fr](mailto:ing@ingfixations.fr)

TELEPHONE :

+33 (0)4 71 05 59 03

FAX :

+33 (0)4 71 09 35 46

## PRODUCTION SITE

### I.N.G. FIXATIONS

Z.I. La Borie 2  
43120 Monistrol-sur-Loire  
France

## WEBSITE

[www.ingfixations.fr](http://www.ingfixations.fr)

