

# I.N.G. FIXATIONS

*Fixation dans les maçonneries pleines et creuses*



## *EVALUATION TECHNIQUE EUROPÉENNE*



**ETE - 18/0137**

**RÉSINE POLYESTER  
300 ml SOC (BEIGE)**





ETA-Danmark A/S  
Göteborg Plads 1  
DK-2150 Nordhavn  
Tel. +45 72 24 59 00  
Fax +45 72 24 59 04  
Internet [www.etadanmark.dk](http://www.etadanmark.dk)

Authorised and notified according  
to Article 29 of the Regulation (EU)  
No 305/2011 of the European  
Parliament and of the Council of 9  
March 2011

MEMBER OF EOTA



## European Technical Assessment ETA-18/0137 of 2018-03-20

### I General Part

**Technical Assessment Body issuing the ETA and designated according to Article 29 of the Regulation (EU) No 305/2011: ETA-Danmark A/S**

**Trade name of the construction product:**

RESINE SOC

**Product family to which the above construction product belongs:**

Bonded anchor with anchor rod made of galvanized steel or stainless steel of sizes M8, M10 and M12, for use in masonry

**Manufacturer:**

ING Fixations  
Z.I. de Chassende,  
BP 90168,  
43005 LE-PUY-EN-VELAY Cedex  
Tel. (33) (0)4 71 05 59 03  
Fax (33) (0)4 71 09 35 46  
Internet: [www.ingfixations.fr](http://www.ingfixations.fr)

**Manufacturing plant:**

Factory Plant 1

**This European Technical Assessment contains:**

25 pages including 20 annexes which form an integral part of the document

**This European Technical Assessment is issued in accordance with Regulation (EU) No 305/2011, on the basis of:**

EAD 330076-00-0604 Metal injection anchors for use in masonry

**This version replaces:**

Translations of this European Technical Assessment in other languages shall fully correspond to the original issued document and should be identified as such.

Communication of this European Technical Assessment, including transmission by electronic means, shall be in full (except the confidential Annexes referred to above). However, partial reproduction may be made, with the written consent of the issuing Technical Assessment Body. Any partial reproduction has to be identified as such.

## **II SPECIFIC PART OF THE EUROPEAN TECHNICAL ASSESSMENT**

### **1 Technical description of product and intended use**

#### **Technical description of the product**

The Injection system RESINE SOC is a bonded anchor (injection type) consisting of a mortar cartridge with RESINE SOC injection mortar PE, a perforated nylon sleeve, and an anchor rod with hexagon nut and washer in the range of M8, M10 and M12.

The steel elements are made of zinc coated steel or stainless steel.

The anchor rod is placed into a drilled hole filled with injection mortar and is anchored via the bond between steel element, injection mortar and masonry.

An illustration of the product and intended use is given in Annex A1 and Annex A3.

The characteristic material values, dimensions and tolerances of the anchors not indicated in Annexes shall correspond to the respective values laid down in the technical documentation<sup>1</sup> of this European Technical Assessment.

The anchors are intended to be used with embedment depth given in Annex A4, Table A1. For the installed anchor see Figure given in Annex A3. The intended use specifications of the product are detailed in the Annex B1.

### **2 Specification of the intended use in accordance with the applicable EAD**

The anchors are intended to be used for anchorages for which requirements for mechanical resistance and stability and safety in use in the sense of the Basic Works Requirements 1 and 4 of Regulation (EU) 305/2011 shall be fulfilled and failure of anchorages made with these products would compromise the stability of the works, cause risk to human life and/or lead to considerable economic consequences.

The anchor is to be used only for anchorages subject to static or quasi-static loading in solid masonry (Masonry Group b) or hollow or perforated masonry (Masonry Group c) according to Annex B9. The mortar strength

class of the masonry has to be M 2,5 according to EN 998-2:2010 at minimum.

The anchors may be installed in Condition w/d: installation in wet substrate and use in structures subjected to dry, internal conditions.

The anchors may be used in the following temperature range:

Ta: -40°C to +40°C (max. short term temperature +40°C and max. long term temperature +24°C),

Tb: -40°C to +80°C (max short term temperature + 80 °C and max long term temperature + 50 °C).

Elements made of galvanized steel or stainless steel may be used in structures subject to dry internal conditions only.

The provisions made in this European Technical Assessment are based on an assumed intended working life of the anchor of 50 years.

The indications given on the working life cannot be interpreted as a guarantee given by the producer or Assessment Body, but are to be regarded only as a means for choosing the right products in relation to the expected economically reasonable working life of the works.

---

<sup>1</sup> The technical documentation of this European Technical Assessment is deposited at ETA-Danmark and, as far as relevant for

the tasks of the Notified bodies involved in the attestation of conformity procedure, is handed over to the notified bodies.

### **3 Performance of the product and references to the methods used for its assessment**

#### **3.1 Characteristics of product**

##### **Mechanical resistance and stability (BWR 1):**

The essential characteristics are detailed in the Annex from C1 to C5.

##### **Safety in case of fire (BWR 2):**

The essential characteristics are detailed in the Annex from C4.

##### **Safety in use (BWR4):**

For basic requirement Safety in use the same criteria are valid for Basic Requirement Mechanical resistance and stability (BWR1).

##### **Sustainable use of natural resources (BWR7)**

No performance determined

Other Basic Works Requirements are not relevant

#### **3.2 Methods of assessment**

The assessment of fitness of the anchor for the intended use in relation to the requirements for mechanical resistance and stability and safety in use in the sense of the Basic Requirements 1 and 4 has been made in accordance with the EAD 330076-00-0604 Metal injection anchors for use in masonry, based on the Use Categories b and c in respect of the base material and Category w/d in respect of installation and use.

In addition to the specific clauses relating to dangerous substances contained in this European Technical Assessment, there may be other requirements applicable to the products falling within its scope (e.g. transposed European legislation and national laws, regulations and administrative provisions). In order to meet the provisions of the Construction Products Regulation, these requirements need also to be complied with, when and where they apply.

## **4 Attestation and verification of constancy of performance (AVCP)**

### **4.1 AVCP system**

According to the decision 1997/177/EC of the European Commission, the system(s) of assessment and verification of constancy of performance (see Annex V to Regulation (EU) No 305/2011) is 1.

## **5 Technical details necessary for the implementation of the AVCP system, as foreseen in the applicable EAD**

Technical details necessary for the implementation of the AVCP system are laid down in the control plan deposited at ETA-Danmark prior to CE marking

Issued in Copenhagen on 2018-03-20 by



Thomas Bruun  
Manager, ETA-Danmark

**Injection Mortar : RESINE SOC Polyester Resin System**

- A) Foil Bag Cartridge 165ml, 300ml
- B) Coaxial Cartridge 380ml, 400ml, 410ml
- C) Side by Side Cartridge 345ml, 825ml

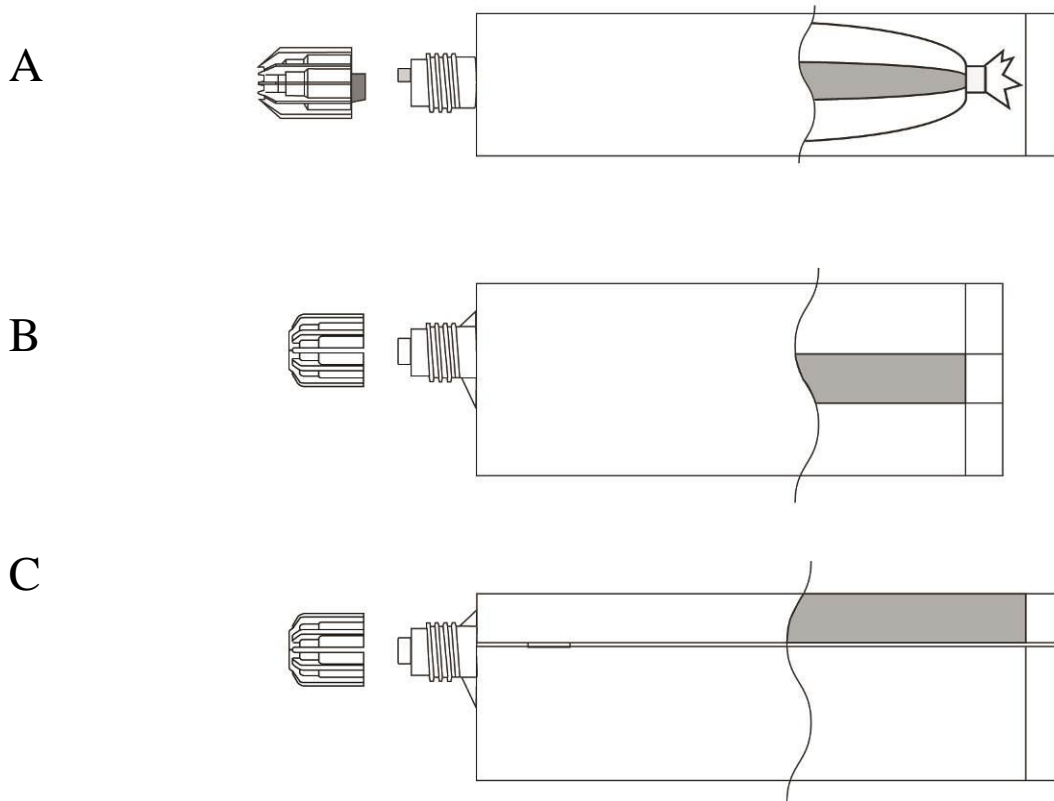

**Use category in respect of the base material:**

Masonry Group b: metal injection anchors for use in solid masonry.

Masonry Group c: metal injection anchors for use in hollow or perforated masonry.

**Use category in respect of installation and use:**

Condition w/d: installation in wet substrate and use in structures subjected to dry, internal conditions.

**Temperature range:**

Ta: -40°C to +40°C (max. short term temperature +40°C and max. long term temperature +24°C)

Tb: -40°C to +80°C (max short term temperature + 80 °C and max long term temperature + 50 °C)

<b>RESINE SOC</b>	<b>Annex A1</b> of European Technical Assessment ETA-18/0137
Product and intended use (1)	



**Mixer (Standard / + Hanger)**

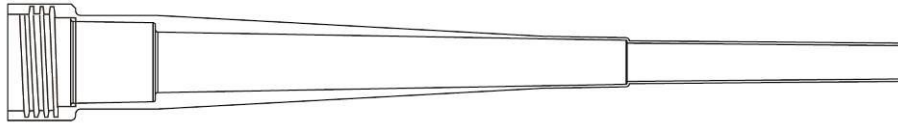

**Threaded Steel Stud / Washer + Nut**

Sizes M8, M10, M12

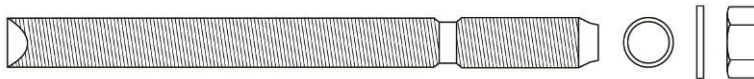

**Perforated Nylon Sleeve**

Size 16/85

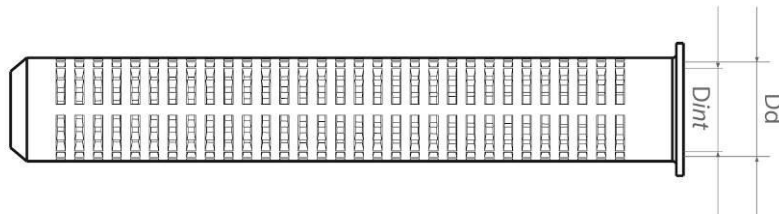

**RESINE SOC**

Product and intended use (2)

**Annex A2**  
of European  
Technical Assessment  
ETA-18/0137

**Anchor application in solid masonry (brick n°1 according to Annex B9)**

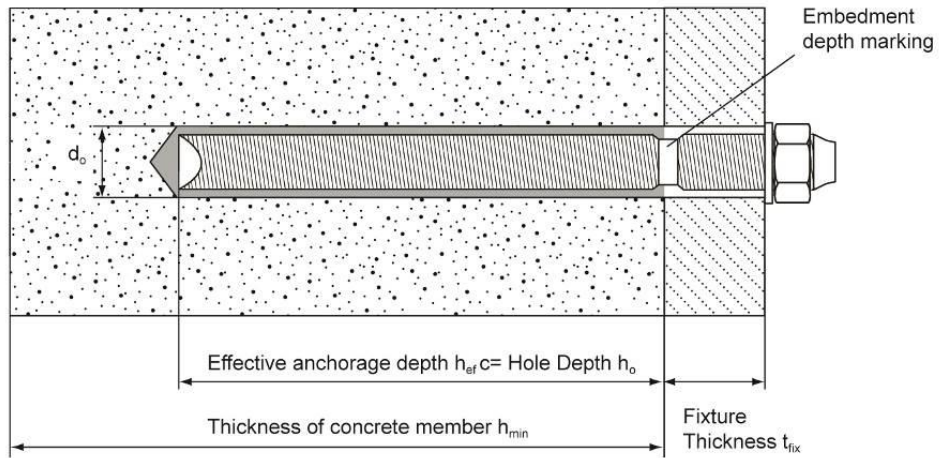

**Anchor application in hollow/perforated masonry with nylon sleeve (brick n°2 according to Annex B9)**

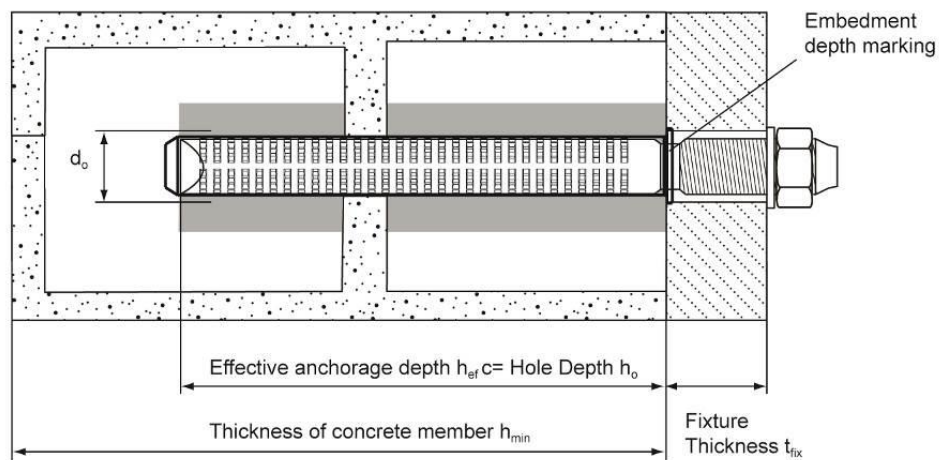

**RESINE SOC**

Product and intended use (3)

**Annex A3**  
of European  
Technical Assessment  
ETA-18/0137

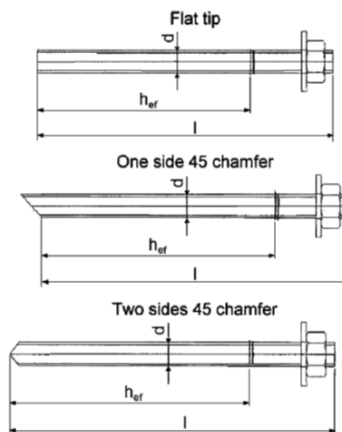

**Table A1: Threaded rod dimensions**

Anchor size			M8	M10	M12
Diameter of anchor rod	d	[mm] =	8	10	12
Size of sleeve	d <sub>nom</sub> x l <sub>s</sub>	[mm] =	16 x 85		
Nominal anchorage depth	h <sub>ef</sub>	[mm] =	85		
Maximum diameter hole in fixture	d <sub>fix</sub>	[mm] ≤	9	12	14
Installation torque moment	T <sub>inst</sub>	[Nm] =	2	2	2
Depth of drilled hole to deepest point	h <sub>1</sub>	[mm] =	90		

- 1) Marking according EAD 330076-00-0604 Metal injection anchors for use in masonry.
- 2) Effective anchorage depths according to the range specified in table 1.

**Table A2: Threaded rods materials**

Designation	Material
<b>Threaded rods made of zinc coated steel</b>	
Threaded rod M8 – M12	Strength class 4.6, 5.8, 6.8 EN ISO 898-1 Steel galvanized ≥ 5µm EN ISO 4042 Hot dipped galvanized ≥ 45µm EN ISO 10684
Washer ISO 7089	Steel galvanized EN ISO 4042; hot dipped galvanized EN ISO 10684
Nut EN ISO 4032	Strength class 8 EN ISO 898-2 Steel galvanized ≥ 5µm EN ISO 4042 Hot dipped galvanized ≥ 45µm EN ISO 10684
<b>Threaded rods made of stainless steel</b>	
Threaded rod M8 – M12	Strength class A4-70 and A4-80 EN ISO 3506-1;
Washer ISO 7089	Strength class A4-70 and A4-80 EN ISO 3506-1;
Nut EN ISO 4032	Strength class A4-70 and A4-80 EN ISO 3506-1;

Commercial standard threaded rods with:

- material and mechanical properties according to Table 2;
- confirmation of material and mechanical properties by inspection certificate 3.1 according to EN-10204:2004;
- marking of the threaded rod with the embedment depth.

<b>RESINE SOC</b>	<b>Annex A4</b> of European Technical Assessment ETA-18/0137
Threaded rod types, dimensions and materials	

**Table A3: Injection mortar**

Product	Composition
<b>RESINE SOC</b> Two components injection mortar	Additive: quartz Bonding agent: polyester resin Hardener: dibenzoyl peroxide

**Table A4: Minimum curing time**

Temperature in the concrete member	Minimum gelling time in dry concrete (mins)	Minimum load time in dry concrete (mins)
≥ - 5°C	40	180
≥ +5°C	20	90
≥ +15°C	9	60
≥ +25°C	5	30
≥ +35°C	3	20

**RESINE SOC**

Materials and curing time

**Annex A5**  
of European  
Technical Assessment  
ETA-18/0137

**Plastic sleeve for hollow/perforated masonry: nominal dimensions and material**

Resin sleeves are the effective way to create a fixing where there is a hollow void, such as for perforated bricks and blocks, or a more porous material for example blockwork. Resin is injected to fill the volume of the sleeve, and then forced through the fine perforations once the metal fixing rod is inserted. This distributes the resin material into the fixing cavity, forming a solid joint between the resin, the sleeve and the fixing.

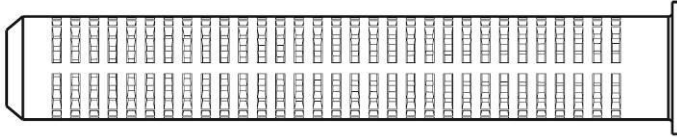

**Nylon Perforated Sleeve – 16 x 85**

Nominal Diameter 16 mm

Nominal Length 85 mm

<b>RESINE SOC</b>	<b>Annex A6</b> of European Technical Assessment ETA-18/0137
Plastic sleeve	

**Use:**

The anchors are intended to be used for anchorages for which requirements for mechanical resistance and stability and safety in use in the sense of the Basic Requirements 1 and 4 of Regulation 305/2011 (EU) shall be fulfilled and failure of anchorages made with these products would compromise the stability of the works, cause risk to human life and/or lead to considerable economic consequences.

**Anchors subject to:**

- Static and quasi-static loads: sizes from M8 to M12.

**Base materials:**

- Solid masonry (Masonry Group b) or hollow or perforated masonry (Masonry Group c) according to Annex B9. The mortar strength class of the masonry has to be M 2,5 according to EN 998-2:2010 at minimum.

**Temperature range:**

The anchors may be used in the following temperature range:

Ta: -40°C to +40°C (max. short term temperature +40°C and max. long term temperature +24°C),

Tb: -40°C to +80°C (max short term temperature + 80 °C and max long term temperature + 50 °C).

**Use conditions (Environmental conditions):**

Threaded rods:

- a) Carbon galvanized steel class 4.6, 5.8 or 6.8 according to EN ISO 898-1 for dry internal conditions.
- b) Stainless steel A4-70 and A4-80 according to EN ISO 3506 for dry internal conditions.

Nuts and washers:

Corresponding to anchor rod material above mentioned for the different environmental exposures.

**Installation:**

- Condition w/d: installation in wet substrate and use in structures subjected to dry, internal conditions.
- Perforation with drilling machine

**Proposed design methods:**

- EOTA Technical Report 054, Design method A

**RESINE SOC**

Intended use - Specification

**Annex B1**  
of European  
Technical Assessment  
ETA-18/0137

**Table B1 Installation data for solid masonry (brick n°1)\***

Size		M8	M10	M12
Nominal drilling diameter	$d_0$ [mm]	10	12	14
Maximum diameter hole in the fixture	$d_{fix}$ [mm]	9	12	14
Embedment depth	$h_{ef}$ [mm]	85	85	85
Depth of the drilling hole	$h_1$ [mm]	$h_{ef} + 5$ mm		
Torque moment	$T_{inst}$ [Nm]	2	2	2
Thickness to be fixed	$t_{fix,min}$ [mm]	> 0		
	$t_{fix,max}$ [mm]	< 1500		
Minimum spacing	$S_{min}$ [mm]	255	255	255
Minimum edge distance	$C_{min}$ [mm]	127,5	127,5	127,5

\* Type of bricks are detailed in the Annex B9

**Table B2: Installation data for hollow/perforated masonry (brick n° 2)\***

Size		M8	M10	M12
<b>Plastic sleeve</b>		<b>16x85</b>		
Nominal drilling diameter	$d_0$ [mm]	16	16	16
Maximum diameter hole in the fixture	$d_{fix}$ [mm]	9	12	14
Embedment depth	$h_{ef}$ [mm]	85	85	85
Depth of the drilling hole	$h_1$ [mm]	$h_{ef} + 5$ mm		
Torque moment	$T_{inst}$ [Nm]	2	2	2
Thickness to be fixed	$t_{fix,min}$ [mm]	> 0		
	$t_{fix,max}$ [mm]	< 1500		
Minimum spacing	$S_{min,  }$ [mm]	560	560	560
	$S_{min,\perp}$ [mm]	200	200	200
Minimum edge distance	$C_{min}$ [mm]	100	100	100

\* Type of bricks are detailed in the Annex B9

**RESINE SOC**

Intended use - data



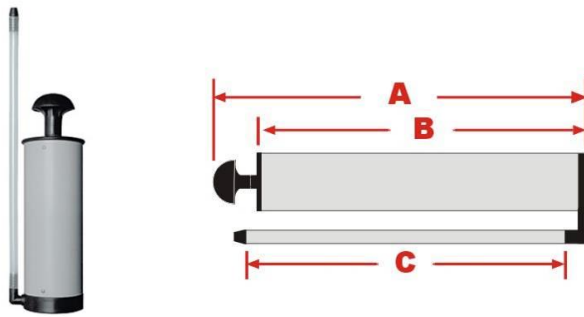

**Annex B2**  
of European  
Technical Assessment  
ETA-18/0137

**Manual blower pump: nominal dimensions**



190mm (240x190x300mm) Article no. 65561	280mm (330x280x300mm) Article no. 65562	400mm (420x370x350mm) Article no. 84106
-( A ) : 240mm (overall)	-( A ) : 330mm (overall)	-( A ) : 420mm (overall)
-( B ) : 190mm (Body)	-( B ) : 280mm (Body)	-( B ) : 370mm (Body)
-( C ) : 300mm (Tube)	-( C ) : 300mm (Tube)	-( C ) : 350mm (Tube)

**Steel Wire Brushes**





	<b>Art. No.</b> 65577	<b>Specification</b> 28 mm
	<b>Art. No.</b> 65576	<b>Specification</b> 18 mm
	<b>Art. No.</b> 65575	<b>Specification</b> 13 mm
	<b>Art. No.</b> 65578	<b>Specification</b> 10 mm

**Table B3: Brush diameter**

Type of threaded rod			Use in solid masonry			Use in hollow/perforated masonry		
			M8	M10	M12	M8	M10	M12
<b>d<sub>o</sub></b>	Nominal drill hole	[mm]	10	12	14	16	16	16
<b>d<sub>b</sub></b>	Brush diameter	[mm]	10	13	13	18	18	18

<b>RESINE SOC</b>	<b>Annex B3</b> of European Technical Assessment ETA-18/0137
Cleaning tools	







<b>Resin injection pump details</b>		
<b>Image</b>	<b>Size Cartridge / Code</b>	<b>Type</b>
	165 / 300ml Art 65463 - 300 ml 10:1	<b>Manual</b>
	345ml Art 65472 - 345 ml 10:1	<b>Manual</b>
	380 / 410ml Art 65464 - 380/410 ml 10:1	<b>Manual</b>
	165 / 300 / 345 / 380 / 410ml Art 66399      300 ml 7.4v Tool Art 65486      345 ml 7.4v Tool Art 65484      380 ml 7.4v Tool	<b>Battery</b>

**RESINE SOC**

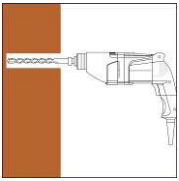
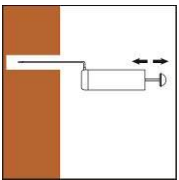
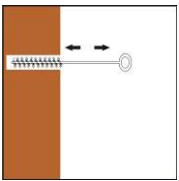
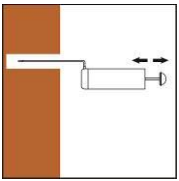
Tools for injection

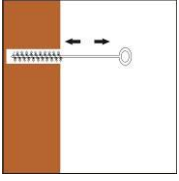
**Annex B4**  
of European  
Technical Assessment  
ETA-18/0137

Instructions for use	
<b>Bore hole drilling</b>	
	<p>Drill hole to the required embedment depth with a hammer drill set in rotation-hammer mode using an appropriately sized carbide drill bit.</p>
<b>Bore hole cleaning</b> Just before setting an anchor, the bore hole must be free of dust and debris.	
<b>a) Manual air cleaning (MAC)</b>	
	<b>X 4</b>
<p>The manual pump may be used for blowing out bore holes</p> <p>Blow out at least 4 times from the back of the bore hole until return air stream is free of noticeable dust.</p>	
	<b>X 4</b>
<p>Brush 4 times with the specified brush size (brush <math>\varnothing \geq</math> bore hole <math>\varnothing</math>, see Table) by inserting the steel brush to the back of the hole (if needed with an extension) in a twisting motion and removing it. The brush must produce natural resistance as it enters the bore hole. If not, the brush is too small and must be replaced with the proper brush diameter.</p>	
	<b>X 4</b>
<p>Blow out again with manual pump at least 4 times until return air stream is free from noticeable dust.</p>	
<b>b) Compressed air cleaning (CAC)</b>	
	<b>X 2</b>
<p>Blow 2 times from the back of the hole (if needed with a nozzle extension) over the hole length with oil-free compressed air (min. 6 bar at 6m<sup>3</sup>/h) until return air stream is free from noticeable dust.</p>	
	<b>X 2</b>
<p>Brush 2 times with the specified brush size (brush <math>\varnothing \geq</math> bore hole <math>\varnothing</math>, see Table ) by inserting the steel brush to the back of the hole (if needed with an extension) in a twisting motion and removing it. The brush must produce natural resistance as it enters the bore hole. If not, the brush is too small and must be replaced with the proper brush diameter.</p>	
	<b>X 2</b>
<p>Blow out again with compressed air at least 2 times until return air stream is free from noticeable dust.</p>	
<b>RESINE SOC</b>	<b>Annex B5</b>
Procedure for solid masonry (1)	of European Technical Assessment ETA-18/0137

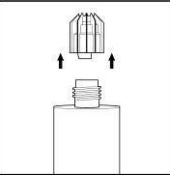
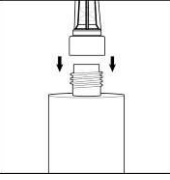
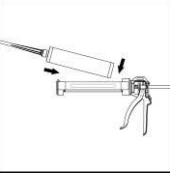
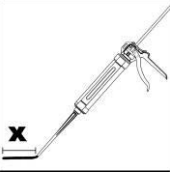
Instructions for use	
	<p>Remove the threaded cap from the cartridge. Cut the bag below the clip if appropriate.</p>
	<p>Tightly attach the mixing nozzle. Do not modify the mixer in any way. Make sure the mixing element is inside the mixer. Use only the supplied mixer with the adhesive.</p>
	<p>Insert the cartridge into the dispenser. Press the release trigger to retract the plunger and insert the cartridge neatly into the cradle without any distortion.</p>
	<p>Discard the initial trigger pulls 10cm of adhesive. Resin will flow from the cartridge as soon as dispensing is initiated.</p>

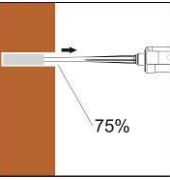
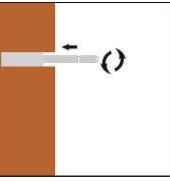
Instructions for use	
	<p>Insert the nozzle to the bottom of the hole and inject the resin until the hole is filled 75%</p>
	<p>Insert the anchor, slowly with a slight twisting motion into the hole. Remove excess resin and leave the fixing until minimum curing (loading) times has elapsed</p>

<p><b>RESINE SOC</b></p>	<p><b>Annex B6</b> of European Technical Assessment ETA-18/0137</p>
<p>Procedure for solid masonry (2)</p>	

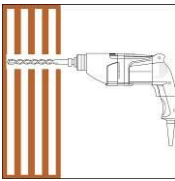
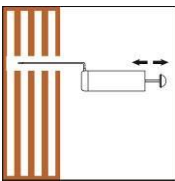
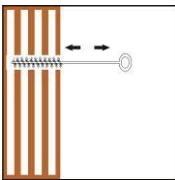
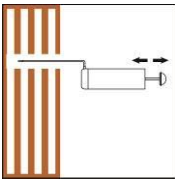
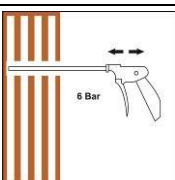
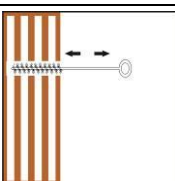
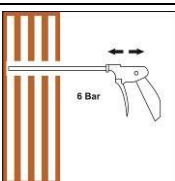
Instructions for use		
Bore hole drilling		
		Drill hole to the required embedment depth with a hammer drill set in rotation-hammer mode using an appropriately sized carbide drill bit.
Bore hole cleaning Just before setting an anchor, the bore hole must be free of dust and debris.		
a) Manual air cleaning (MAC)		
	<b>X 4</b>	The manual pump may be used for blowing out bore holes  Blow out at least 4 times from the back of the bore hole until return air stream is free of noticeable dust.
	<b>X 4</b>	Brush 4 times with the specified brush size (brush $\varnothing \geq$ bore hole $\varnothing$ , see Table) by inserting the steel brush to the back of the hole (if needed with an extension) in a twisting motion and removing it. The brush must produce natural resistance as it enters the bore hole. If not, the brush is too small and must be replaced with the proper brush diameter.
	<b>X 4</b>	Blow out again with manual pump at least 4 times until return air stream is free from noticeable dust.
b) Compressed air cleaning (CAC)		
	<b>X 2</b>	Blow 2 times from the back of the hole (if needed with a nozzle extension) over the hole length with oil-free compressed air (min. 6 bar at 6m <sup>3</sup> /h) until return air stream is free from noticeable dust.
	<b>X 2</b>	Brush 2 times with the specified brush size (brush $\varnothing \geq$ bore hole $\varnothing$ , see Table ) by inserting the steel brush to the back of the hole (if needed with an extension) in a twisting motion and removing it. The brush must produce natural resistance as it enters the bore hole. If not, the brush is too small and must be replaced with the proper brush diameter.
	<b>X 2</b>	Blow out again with compressed air at least 2 times until return air stream is free from noticeable dust.
<b>RESINE SOC</b>		<b>Annex B7</b> of European Technical Assessment ETA-18/0137
Procedure for hollow/perforated masonry (1)		

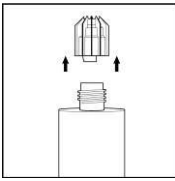
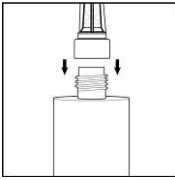
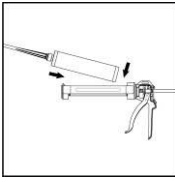
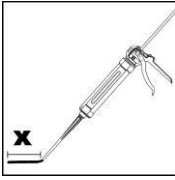
Instructions for use	
	Remove the threaded cap from the cartridge without cutting.
	Tightly attach the mixing nozzle. Do not modify the mixer in any way. Make sure the mixing element is inside the mixer. Use only the supplied mixer with the adhesive.
	Insert the cartridge into the dispenser. Press the release trigger to retract the plunger and insert the cartridge neatly into the cradle without any distortion.
	Discard the initial trigger pulls 10cm of adhesive. Resin will flow from the cartridge as soon as dispensing is initiated.

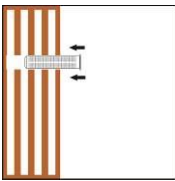
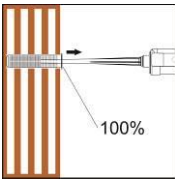
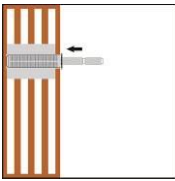
Instructions for use	
	Introduce the sleeve of suitable dimension (see table) to the back of the hole so that the collar is level with the hole face. The cap may be opened to allow full nozzle insertion.
	Insert the nozzle to the end of the sleeve and inject the resin until the sleeve is 100% filled. Close the cap.
	Insert the anchor, slowly with a slight twisting motion into the sleeve. Remove excess resin and leave the fixing until minimum curing (loading) times has elapsed

<b>RESINE SOC</b>	<b>Annex B8</b> of European Technical Assessment ETA-18/0137
Procedure for hollow/perforated masonry (2)	

**Table B5: Type of solid (Brick N° 1) and hollow/perforated masonry (Brick N° 2)**

**Solid Brick**



Dimensions [mm]: 120 x 250 x 60  
 $f_b$  class  $\geq 40 \text{ N/mm}^2$   
 density  $\rho_m \geq 1666,7 \text{ kg/m}^3$   
 (e.g. type "Mattone Pieno")

**Hollow/Perforated**

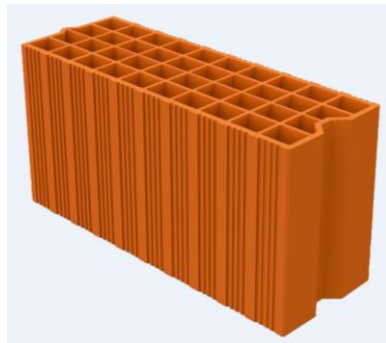

Dimensions [mm]: 200 x 560 x 274  
 $f_b$  class  $\geq 8,5 \text{ N/mm}^2$   
 density  $\rho_m \geq 600 \text{ kg/m}^3$   
 (e.g. type "French brick")

**RESINE SOC**

Type and dimensions of brick

**Annex B9**  
 of European  
 Technical Assessment  
 ETA-18/0137

**Table C1: Essential Characteristics**

ESSENTIAL CHARACTERISTICS		PERFORMANCE		
Installation parameters		M8	M10	M12
d [mm]		8	10	12
d <sub>0</sub> [mm] category b (solid masonry)		10	12	14
d <sub>0</sub> [mm] category c (hollow or perforated masonry)		16	16	16
Type of plastic sleeve for use in category c		16x85	16x85	16x85
d <sub>fix</sub> [mm]		9	12	14
h <sub>i</sub> [mm]		h <sub>ef</sub> + 5 mm		
t <sub>fix</sub> [mm]	Min	> 0		
	Max	≤ 1500 mm		
T <sub>inst</sub> [Nm] category b (solid masonry)		2	2	2
T <sub>inst</sub> [Nm] category c (hollow or perforated masonry)		2	2	2
S <sub>min</sub> [mm] category b (solid masonry)		255	255	255
C <sub>min</sub> [mm] category b (solid masonry)		127,5	127,5	127,5
S <sub>min</sub> [mm] category c (hollow masonry) S <sub>min,  </sub>		560	560	560
S <sub>min</sub> [mm] category c (hollow) S <sub>min,⊥</sub>		200	200	200
C <sub>min</sub> [mm] category c (hollow masonry)		100	100	100
<b>* Resistance for tensile and shear load Temperature range -40°C/+40°C (T<sub>mlp</sub> = 24°C)</b>		<b>M8</b>	<b>M10</b>	<b>M12</b>
Brick n°1 (solid)	N <sub>Rk</sub> [kN]	2,5		
	V <sub>Rk</sub> [kN]	6,0		
Brick n°2 (hollow)	N <sub>Rk</sub> [kN]	0,75		
	V <sub>Rk</sub> [kN]	3,5		
<b>* Resistance for tensile and shear load Temperature range -40°C to +80°C (T<sub>mlp</sub> = 50°C)</b>		<b>M8</b>	<b>M10</b>	<b>M12</b>
Brick n°1 (solid)	N <sub>Rk</sub> [kN]	2,0		
	V <sub>Rk</sub> [kN]	6,0		
Brick n°2 (hollow)	N <sub>Rk</sub> [kN]	0,6		
	V <sub>Rk</sub> [kN]	3,5		

\* For design according to EOTA Technical Report 054: N<sub>Rk</sub> = N<sub>Rk,p</sub> = N<sub>Rk,b</sub> = N<sub>Rk,pb</sub> – steel failure is not decisive

\* For design according to EOTA Technical Report 054: V<sub>Rk</sub> = V<sub>Rk,b</sub> – steel failure without lever arm is not decisive – V<sub>Rk,c</sub> according to EOTA Technical Report 054

**RESINE SOC**

Performance for static and quasi-static loads: Resistances

**Annex C1**  
of European  
Technical Assessment  
ETA-18/0137

**Table C2: Characteristic bending moments**

Size			M8	M10	M12
Characteristic resistance with standard threaded rod grade 4.6	$M_{Rk,s}$	[Nm]	15	30	52
Partial safety factor	$\gamma_{Ms}$	[-]	1,67		
Characteristic resistance with standard threaded rod grade 5.8	$M_{Rk,s}$	[Nm]	19	37	66
Partial safety factor	$\gamma_{Ms}$	[-]	1,25		
Characteristic resistance with standard threaded rod grade 6.8	$M_{Rk,s}$	[Nm]	22	45	79
Partial safety factor	$\gamma_{Ms}$	[-]	1,25		
Characteristic resistance with standard threaded rod stainless steel A4-70 (class 70)	$M_{Rk,s}$	[Nm]	26	52	92
Partial safety factor	$\gamma_{Ms}$	[-]	1,56		
Characteristic resistance with standard threaded rod stainless steel A4-80 (class 80)	$M_{Rk,s}$	[Nm]	30	60	105
Partial safety factor	$\gamma_{Ms}$	[-]	1,33		

**RESINE SOC**

Performance for static and quasi-static loads: Resistances

**Annex C2**  
of European  
Technical Assessment  
ETA-18/0137



**Table C3: Characteristic values for tension and shear load.**

ESSENTIAL CHARACTERISTICS		PERFORMANCE		
<b>* Resistance for tensile and shear load</b> <b>Temperature range -40°C/+40°C (T<sub>mp</sub> = 24°C) and</b> <b>-40°C to +80°C (T<sub>mp</sub> = 50°C)</b>		<b>M8</b>	<b>M10</b>	<b>M12</b>
γ <sub>Mm</sub> [-] Category w/d		2,50		
Brick n°1	S <sub>cr,N</sub> [mm]	255	255	255
	C <sub>cr,N</sub> [mm]	127,5	127,5	127,5
Brick n°2	S <sub>cr,N,  </sub> [mm]	560	560	560
	S <sub>cr,N ⊥</sub> [mm]	200	200	200
	C <sub>cr,N</sub> [mm]	100	100	100
<b>β coefficient for in situ test (EOTA 053)</b> <b>Temperature range: -40°C/+40°C</b>		<b>M8</b>	<b>M10</b>	<b>M12</b>
Brick N° 1 - Solid brick	β [-]	0,57		
Brick N° 2 - French Brick	β [-]	0,60		
<b>β coefficient for in situ test (EOTA TR 053)</b> <b>Temperature range: -40°C/+80°C</b>		<b>M8</b>	<b>M10</b>	<b>M12</b>
Brick N° 1 - Solid brick	β [-]	0,45		
Brick N° 2 - French Brick	β [-]	0,47		
<b>Displacement under service load</b>				
<b>Tensile load</b>				
<b>Temperature range -40°C/+40°C (T<sub>mp</sub> = 24°C)</b>				
<b>Brick n°1 – Solid brick</b>		<b>M8</b>	<b>M10</b>	<b>M12</b>
Admissible service load in tensile	F [kN]	0,71		
Displacement	δ <sub>N0</sub> [mm]	0,02		
	δ <sub>N∞</sub> [mm]	0,05		
<b>Brick n°2 – Hollow/perforated brick</b>		<b>M8</b> <b>With sleeve</b>	<b>M10</b> <b>With sleeve</b>	<b>M12</b> <b>With sleeve</b>
Admissible service load in tensile	F [kN]	0,21		
Displacement	δ <sub>N0</sub> [mm]	0,03		
	δ <sub>N∞</sub> [mm]	0,05		
<b>Displacement under service load</b>				
<b>Tensile load</b>				
<b>Temperature range -40°C to +80°C (T<sub>mp</sub> = 50°C)</b>				
<b>Brick n°1 – Solid brick</b>		<b>M8</b>	<b>M10</b>	<b>M12</b>
Admissible service load in tensile	F [kN]	0,57		
Displacement	δ <sub>N0</sub> [mm]	0,03		
	δ <sub>N∞</sub> [mm]	0,06		
<b>Brick n°2 – Hollow/perforated brick</b>		<b>M8</b> <b>With sleeve</b>	<b>M10</b> <b>With sleeve</b>	<b>M12</b> <b>With sleeve</b>
Admissible service load in tensile	F [kN]	0,17		
Displacement	δ <sub>N0</sub> [mm]	0,03		
	δ <sub>N∞</sub> [mm]	0,07		
<b>RESINE SOC</b>				<b>Annex C3</b> of European Technical Assessment ETA-18/0137
Performance for static and quasi-static loads: Resistances				

**Table C3 cont.: Characteristic values for tension and shear load.**

ESSENTIAL CHARACTERISTICS		PERFORMANCE		
<b>Displacement under service load</b>				
<b>Shear load</b>				
<b>Temperature range -40°C/+40°C (T<sub>mp</sub> = 24°C) and -40°C to +80°C (T<sub>mp</sub> = 50°C)</b>				
<b>Brick n°1 – Solid brick</b>		<b>M8</b>	<b>M10</b>	<b>M12</b>
Admissible service load in shear	F [kN]	1,71		
Displacement	δ <sub>v0</sub> [mm]	0,45		
	δ <sub>v∞</sub> [mm]	0,68		
<b>Brick n°2 – Hollow/perforated brick</b>		<b>M8 With sleeve</b>	<b>M10 With sleeve</b>	<b>M12 With sleeve</b>
Admissible service load in shear	F [kN]	1,00		
Displacement	δ <sub>v0</sub> [mm]	1,15		
	δ <sub>v∞</sub> [mm]	1,73		

**Table C4: Reaction to fire.**

ESSENTIAL CHARACTERISTICS	PERFORMANCE
<b>Reaction to fire</b>	In the final application the thickness of the mortar layer is about 1 to 2 mm and most of the mortar is material classified class A1 according to EC Decision 96/603/EC. Therefore, it may be assumed that the bonding material (synthetic mortar or a mixture of synthetic mortar and cementitious mortar) in connection with the metal anchor in the end use application do not make any contribution to fire growth or to the fully developed fire and they have no influence to the smoke hazard.

**Table C5: Resistance to fire.**

ESSENTIAL CHARACTERISTICS	PERFORMANCE
<b>Resistance to fire</b>	NPD

**RESINE SOC**

Performance for static and quasi-static loads: Resistances

**Annex C4**  
of European  
Technical Assessment  
ETA-18/0137

**Table C6: Terminology and symbols**

TERMINOLOGY AND SYMBOLS	
d	Diameter of anchor bolt or thread diameter
d <sub>0</sub>	Drill hole diameter
d <sub>fix</sub>	Diameter of clearance hole in the fixture
h <sub>ef</sub>	Effective anchorage depth
h <sub>i</sub>	Depth of the drilling hole
T <sub>inst</sub>	Torque moment to installation
t <sub>fix</sub>	Thickness to be fixed
S <sub>min</sub>	Minimum allowable spacing
C <sub>min</sub>	Minimum allowable edge distance
N <sub>Rk</sub>	Characteristic tensile resistance for single anchor
V <sub>Rk</sub>	Characteristic shear resistance for single anchor
γ <sub>Mm</sub>	Partial safety factors
S <sub>cr,N</sub>	Spacing for ensuring the transmission of the characteristic tensile resistance of a single anchor without spacing and edge effects
C <sub>cr,N</sub>	Edge distance for ensuring the transmission of the characteristic tensile resistance of a single anchor without spacing and edge effects
β	Factor according to EOTA TR 053
F	Service load
δ <sub>0</sub>	Short term displacement under service load
δ <sub>c</sub>	Long term displacement under service load
NPD	No performance declared

RESINE SOC

Terminology and symbols

**Annex C5**  
of European  
Technical Assessment  
ETA-18/0137