

**I.N.G.
FIXATIONS**

Le choix du PRO !

INVENTEUR ET FABRICANT DE FIXATIONS DEPUIS 1985



GAMME SANITAIRE

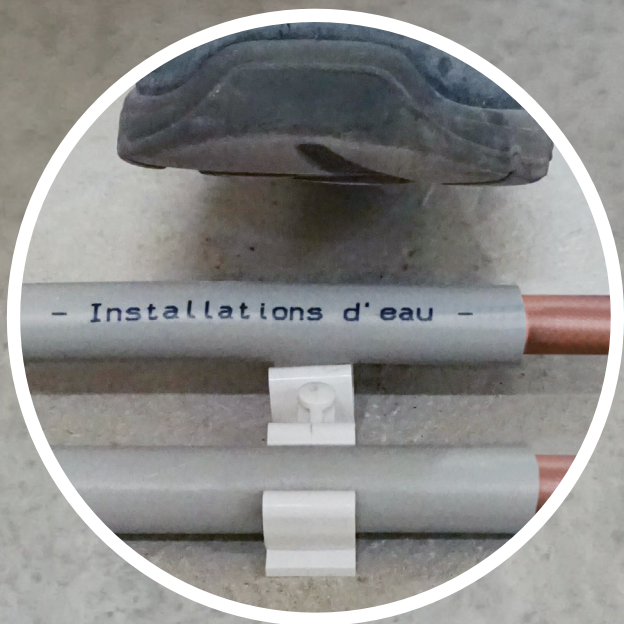

**FIX-RING
MULTI®**
INFO P. 5

SOMMAIRE

 Page 2	 Page 3	 Page 4	 Page 5 (plomberie)	 Page 6	 Page 6	 Page 7	 Page 8
 Page 9	 Page 10	 Page 10	 Page 11	 Page 11	 Page 12	 Page 12	 Page 13
 Page 13	 Page 13	 Page 14 et 15	 Page 15	 Pages 15	 Page 15	 Page 16	 Page 17
 Page 17	 Page 17	 Page 18	 Page 18	 Page 18	 Page 18	 Page 18	 Page 19
 Page 19	 Page 19	 Page 20	 Page 20	 Page 20	 Page 20	 Page 21	 Page 21
 Page 22	 Page 22	 Page 22	 Page 23	 Page 23	 Page 23	 Page 23	 Page 23
 Page 24	 Page 24	 Page 24	 Page 24	 Page 24	 Page 25	 Page 25	 Page 26
 Page 26	 Page 26	 Page 26	 Page 26	 Page 26	 Page 27	 Page 27	 Page 28
 Page 28	 Page 28	 Page 29	 Page 29	 Page 29	 Page 29	 Page 29	 Page 30
 Page 30	 Page 30	 Page 30	 Page 30	 Page 30	 Page 31	 Page 31	 Page 31
 Profil acier, manchon, plaque de verrouillage, console, renfort de console, support renforcé, omega, pied pour profil, penderon... Page 32 à 37		 Page 34	 Page 35	 Page 37	 Page 38 (électricité)	 Page 39	
 Page 39	 Page 39	 Page 40	 Page 40	 Page 40	 Page 41	 Page 41	 Page 42
 Page 42	 Page 42	 Page 42	 Page 42				

NOUVEAU

Le choix du Pro !

FIX-RING VS® - FIXATION DE TUYAUX D'ÉVACUATION SUR TIGE FILETÉE EN VIDE SANITAIRE OU FAUX-PLAFOND



M6
M7

M8

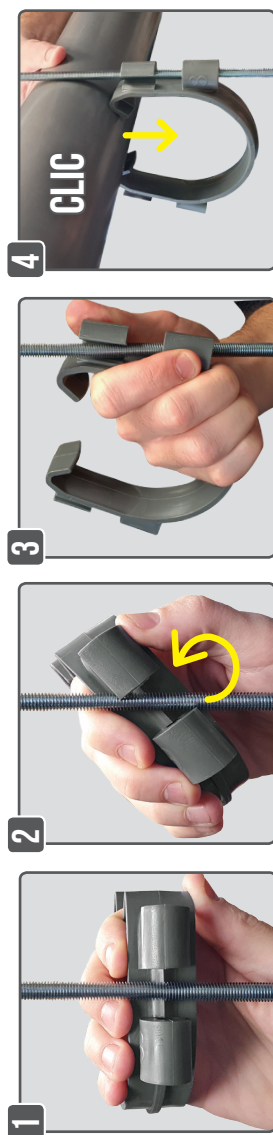

4

CLIC

3

2

1

Ø (mm)	Référence	Condt
100	A140502	Boîte de 10
	A854100	Sachet de 4



Vue en coupe

Forme bombée pour s'adapter à la pente

FIX-RING STEEL® - FIXATION DE GAINES SUR TREILLIS OU TIGE FILETÉE



PRODUIT EN
MATIÈRE RECYCLÉE



SIMPLE



DOUBLE

POSE AU SOL

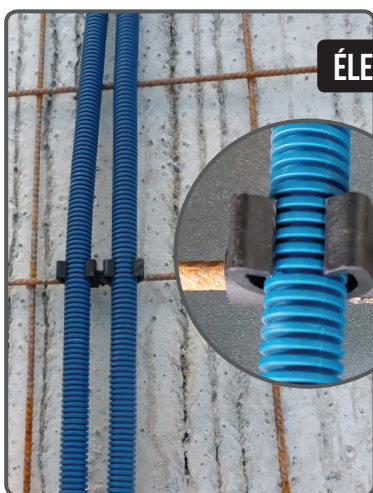

FER À BÉTON

POSE EN FAUX-PLAFOND



TIGE FILETÉE

ÉLECTRICITÉ / PLOMBERIE

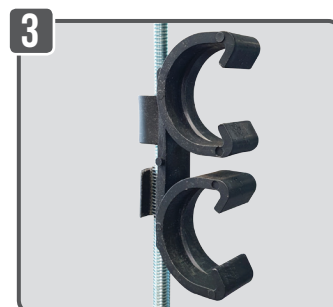
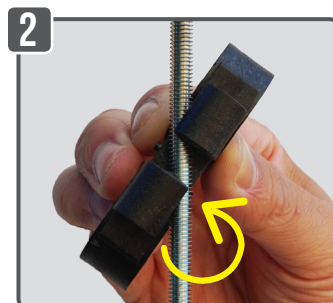
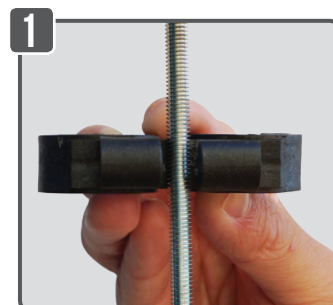

Facile et rapide à mettre en place :
clipsez la fixation sur le treillis ou la tige filetée

M6

Désignation	Ø (mm)	Référence	Condt
SIMPLE	16	A333000	Boîte de 100
	20	A333005	
	22	A333010	
DOUBLE	20	A333030	Boîte de 50
	22	A333035	
	25	A333040	

M8

Désignation	Ø (mm)	Référence	Condt
DOUBLE	20	A333090	Boîte de 50
	22	A333095	
	25	A333100	

FIX-RING® - FIXATION DE GAINES ET TUBES

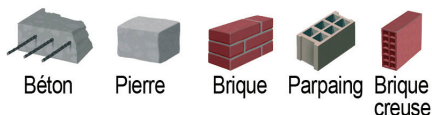

L'Original depuis 1997!

CARACTÉRISTIQUES

- Polyamide 6
- Perçage Ø8 mm
- Percer - Frapper avec un marteau - C'est fixé !
- Rupture à l'arrachement : **40 kg**

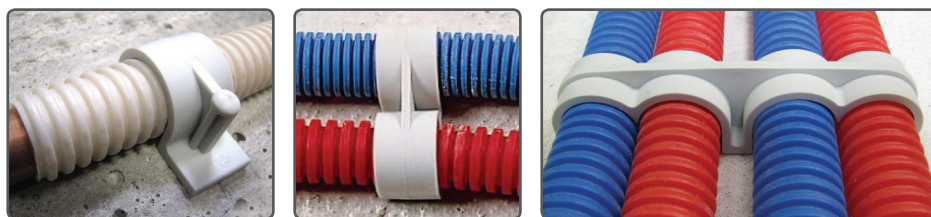

BOÎTES

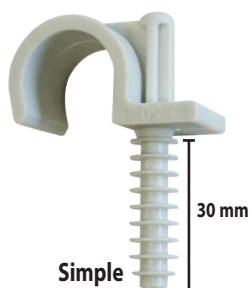

Simple

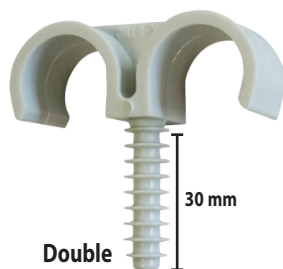

Double

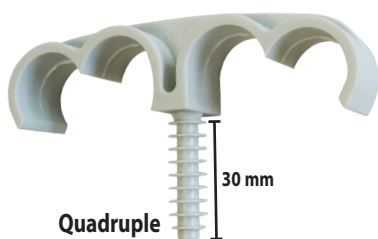

Quadruple

NOUVEAU
Ø 40 ET 45

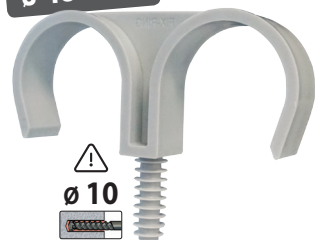

⚠
Ø 10



POUR TUBE MULTICOUCHE ISOLÉ

UTILISATION PRINCIPALE : POUR RELIER LA NOURRICE AU GÉNÉRATEUR DE CHALEUR

FIX-RING®	Ø (mm)	Référence	Condt	Surcondt	Compatibilité
Simple	14	A300030	Boîte de 100	Carton de 16 boîtes	
	16	A300050	Boîte de 100	Carton de 16 boîtes	WICU Ø10-12 Gainé ICT - Tube IRO Ø16
	18	A300100	Boîte de 100	Carton de 16 boîtes	Tube cuivre gainé Ø12-14 WICU Ø12-14
	20	A300200	Boîte de 100	Carton de 16 boîtes	Tube cuivre gainé Ø14-16 WICU Ø14-16 Gainé ICT - Tube IRO Ø20
	22	A300300	Boîte de 100	Carton de 16 boîtes	PER Ø12 WICU Ø16-18 Tube cuivre gainé Ø16-18
	25	A300400	Boîte de 100	Carton de 12 boîtes	PER Ø16 Gainé ICT - Tube IRO Ø25
	28	A300500	Boîte de 100	Carton de 12 boîtes	PER Ø20
	32	A300600	Boîte de 50	Carton de 16 boîtes	Gainé ICT - Tube IRO Ø32

FIX-RING®	Ø (mm)	Référence	Condt	Surcondt	Compatibilité
Double	16	A301650	Boîte de 100	Carton de 16 boîtes	WICU Ø10-12 Gainé ICT - Tube IRO Ø16
	18	A301700	Boîte de 100	Carton de 12 boîtes	Tube cuivre gainé Ø12-14 WICU Ø12-14
	20	A301750	Boîte de 100	Carton de 12 boîtes	Tube cuivre gainé Ø14-16 WICU Ø14-16 Gainé ICT - Tube IRO Ø20
	22	A301800	Boîte de 100	Carton de 9 boîtes	PER Ø12 WICU Ø16-18 Tube cuivre gainé Ø16-18
	25	A301850	Boîte de 100	Carton de 9 boîtes	PER Ø16 Gainé ICT - Tube IRO Ø25
	28	A301900	Boîte de 50	Carton de 12 boîtes	PER Ø20
		40	A301910	Boîte de 20	Carton de 12 boîtes
	45	A301920	Boîte de 20	Carton de 12 boîtes	

FIX-RING®	Ø (mm)	Référence	Condt	Surcondt	Compatibilité
Quadruple	20 - 22	A302500	Boîte de 50	Carton de 12 boîtes	Électriciens: gaines arrivant au tableau Plombier: tubes arrivant au collecteur
	25 - 26	A302600	Boîte de 50	Carton de 9 boîtes	

SEAUX



FIX-RING®	Ø (mm)	Référence	Condt
Simple	16	A301510	Seau de 300
	20	A301520	Seau de 250
	25	A301522	Seau de 150

FIX-RING®	Ø (mm)	Référence	Condt
Double	16	A301529	Seau de 200
	20	A301530	Seau de 150

FIX-RING MULTI® - POUR LA FIXATION DE TUBE MULTICOUCHE, PER ET CUIVRE GAINÉ



PATENT PENDING

E.U. MODEL



Béton



Pierre



Brique



Parpaing



Brique creuse

Double

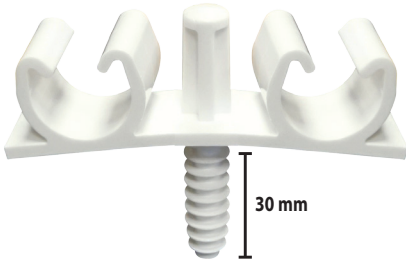

Quadruple

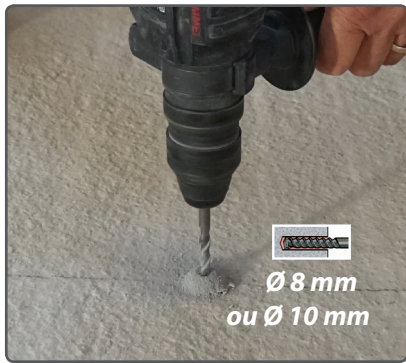
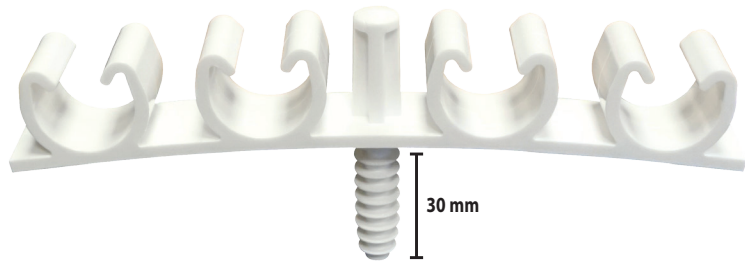

Percez

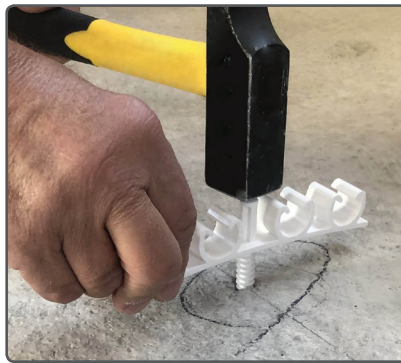

Frappez

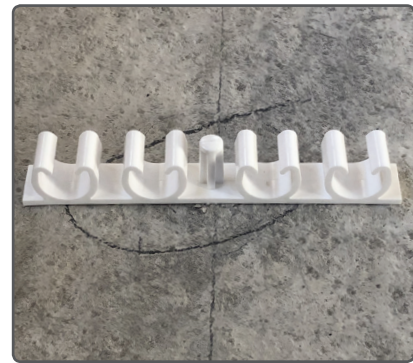

Le FIX-RING MULTI quadruple est mis en place !



Tube cuivre gainé

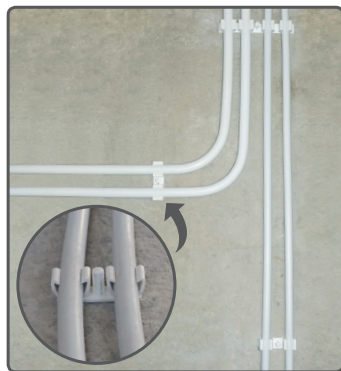

Tube multicouche



Tube PER



Box de
20 boîtes : Ø 16 à 20
ou 16 boîtes : Ø 22 à 26

CARACTÉRISTIQUES

- Polyamide 6
- Multi-diamètre
- Travail plus juste : le fait de fixer les tuyaux avant permet de minimiser les chutes
- Tous matériaux
- Perçage Ø 8 mm (Ø 16 à 20)
Ø 10 mm (Ø 22 à 26)
- Percer - Frapper avec un marteau - C'est fixé !

FIX-RING Multi®	Ø (mm)	Référence	Cond't	Surcond't
Double	16 à 20	A332000	Boîte de 50	Carton de 12 boîtes
	22 à 26	A332200		Carton de 9 boîtes
FIX-RING Multi®	Ø (mm)	Référence	Cond't	Surcond't
Quadruple	16 à 20	A332100	Boîte de 25	Carton de 12 boîtes
	22 à 26	A332300		Carton de 9 boîtes

TUB-RING® - POUR LA FIXATION DE TUBE MULTICOUCHE



Simple



Double

TUB-RING®	Ø (mm)	Référence	Condt	Surcondt
Simple	15 - 16	A315110	Boîte de 100	Carton de 16 boîtes
	20	A315120	Boîte de 100	Carton de 12 boîtes
	25 - 26	A315130	Boîte de 50	Carton de 16 boîtes
	32	A315140	Boîte de 30	Carton de 16 boîtes
Double	15 - 16	A315220	Boîte de 50	Carton de 16 boîtes
	20	A315230	Boîte de 50	Carton de 12 boîtes
	25 - 26	A315240	Boîte de 40	Carton de 12 boîtes

CARACTÉRISTIQUES

- ▶ Durable dans le temps, ne s'ouvre pas (sécurité)
- ▶ Bonne distance du mur pour le passage de l'isolant
- ▶ Utilisation de la pince à sertir sans démontage du tube

FERMETURE ROBUSTE

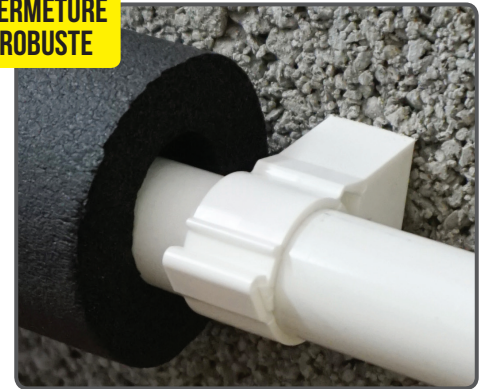

NOIR



Simple



Double

TUB-RING®	Ø (mm)	Référence	Condt	Surcondt
Simple	15 - 16	A315910	Boîte de 100	Carton de 16 boîtes
	20	A315915	Boîte de 100	Carton de 12 boîtes
	25 - 26	A315920	Boîte de 50	Carton de 16 boîtes
	32	A315930	Boîte de 30	Carton de 16 boîtes
Double	15 - 16	A315960	Boîte de 50	Carton de 16 boîtes
	20	A315965	Boîte de 50	Carton de 12 boîtes
	25 - 26	A315970	Boîte de 40	Carton de 12 boîtes



FIX-RING CLIM® - ATTACHE POUR LA CLIMATISATION

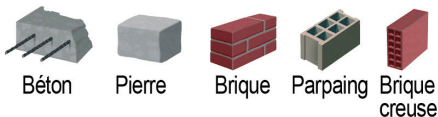

Désignation	Référence	Condt	Surcondt
FIX-RING CLIM®	A313110	Boîte de 50	Carton de 9 boîtes
	A863350	Sachet de 15	Boîte de 10 sachets



FIXATION RADIATEUR FONTE

**SUR MATÉRIAUX CREUX AVEC DOUBLAGE : ISOLANT + PLAQUE DE PLÂTRE
OU SUR MUR ANCIEN**



KIT COMPLET

FIXATION HAUTE x 2

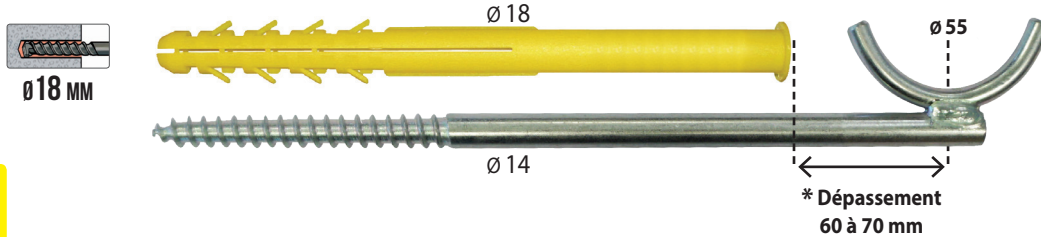

FIXATION BASSE x 2

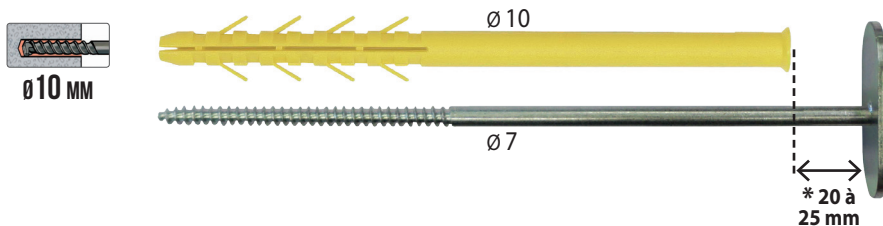

* Exemple pour un radiateur de 100 mm de largeur

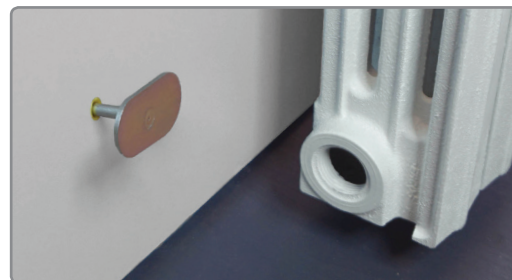
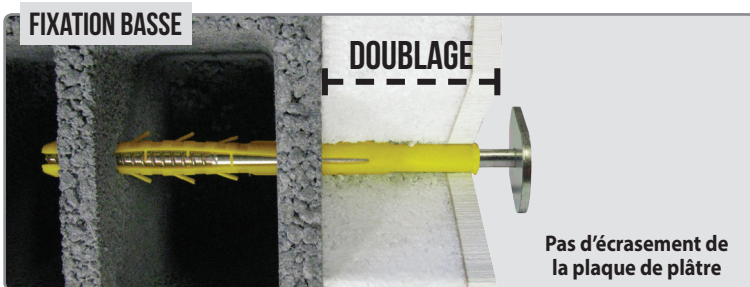
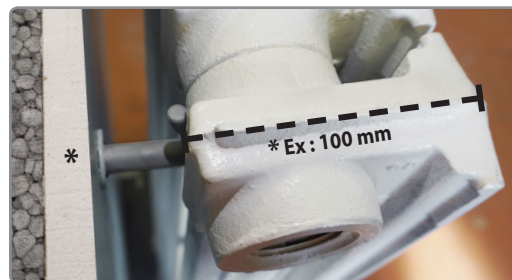
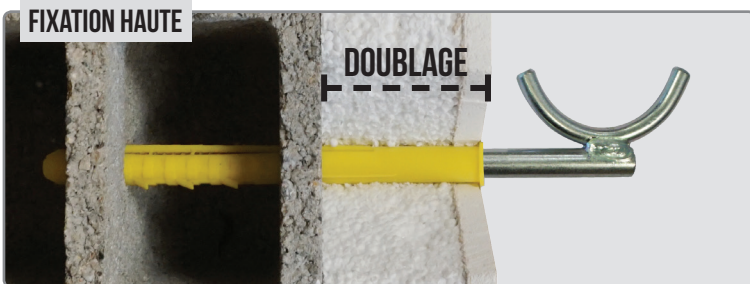

⚠ Pour un radiateur plus large, il faut combiner entre la longueur de la cheville et la longueur de la pièce en acier.
Ex : cheville ø 18 x 200 avec tige acier ø 14 x 310 pour un dépassement de 110 mm.

- Pour murs anciens ou murs avec doublage
- Expansion sur plusieurs alvéoles du parpaing ou de la brique : **forte tenue !**

Ø (mm)	L (mm)	Épaisseur doublage (mm)	Référence	Contd
18	160	-	A186115	Le kit : 2 fixations HAUTES + 2 fixations BASSES
	200	70	A186117	
	240	110	A186120	
	300	170	A186122	



FIXATION CHAUFFE-EAU

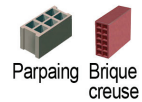

SANS DOUBLAGE

FIXATION DANS PARPAING

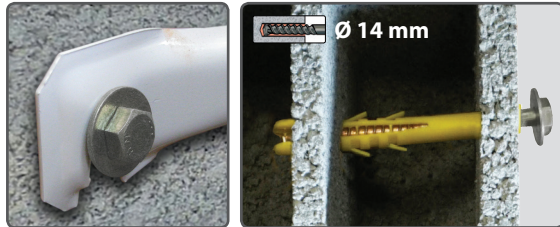

FIXATION DANS BRIQUE

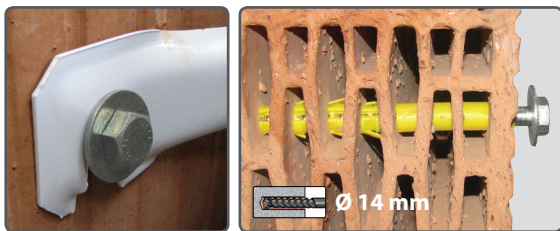

KIT PLAK-PLÂTRE - AVEC DOUBLAGE

ISOLANT + PLAQUE DE PLÂTRE

FIXATION HAUTE

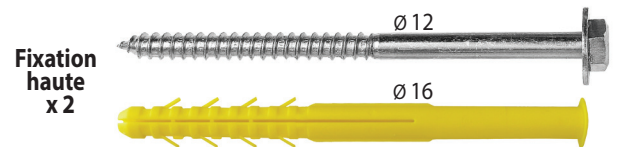

FIXATION BASSE

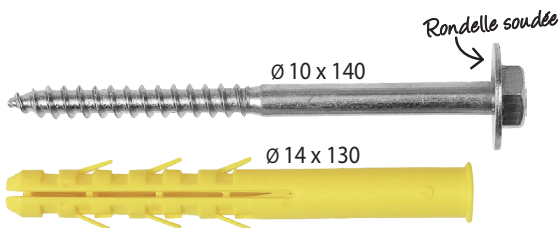

Ø x L (mm)	Référence	Condt
14 x 130 rondelle soudée	A150010	Boîte de 32
	A150020	Boîte de 20
	A150030	Sachets de 4
14 x 130 - VRAC rondelle non soudée	A853220	Sachets de 4

CHEVILLE CHAUFFE-EAU AVEC VIS DOUBLE FILET

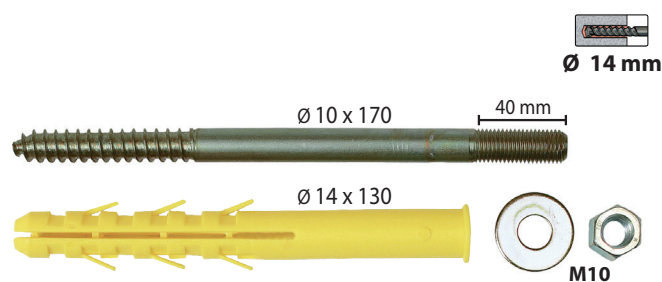

Ø x L (mm)	Référence	Condt
14 x 130 vis double filet	A150040	Sachets de 4

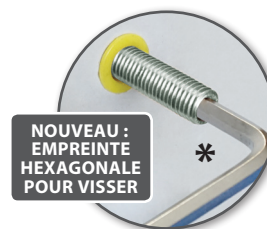

NOUVEAU : EMPREINTE HEXAGONALE POUR VISSER *

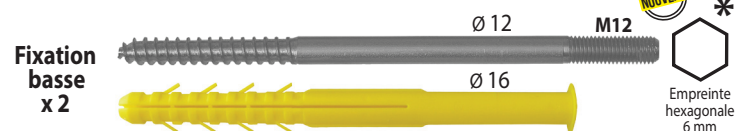

Écrou rondelle soudée NOUVEAU

Ø x L (mm)	Référence	Condt	Surcondt	Doublage maximum
16 x 200	A150060	Le kit	5 sachets	70 mm
16 x 240	A150080			110 mm
16 x 300	A150085			170 mm

FIXATION UNIVERSELLE M6 - M8



SANS DOUBLAGE

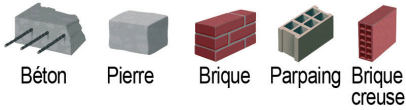

Double taraudage : adaptable M6 et M8

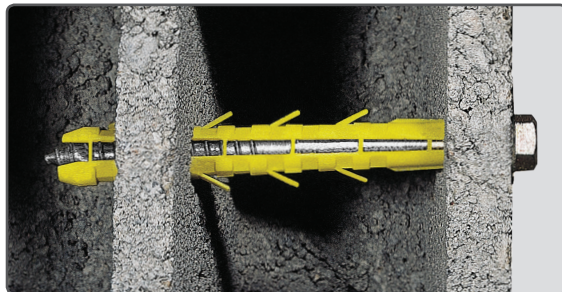
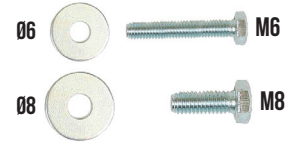
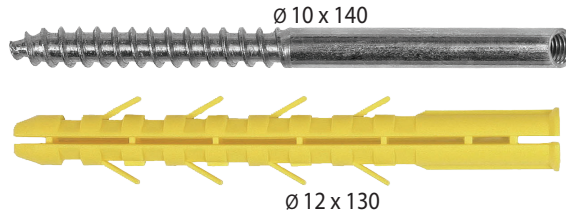
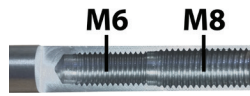

CARACTÉRISTIQUES

- ▶ Épaisseur maxi de la pièce à fixer : **3 mm**
- ▶ Cheville fendue sur toute la longueur : **expansion totale sur les 2 alvéoles du parpaing !**
- ▶ Ailettes anti-rotation

Ø x L (mm)	Référence	Condt	Surcondt
12 x 130	A160460	Boîte de 20	-
	A855713	Sachet de 2	5 sachets



AVEC DOUBLAGE : ISOLANT + PLAQUE DE PLÂTRE

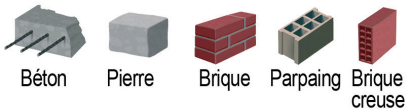

Double taraudage : adaptable M6 et M8

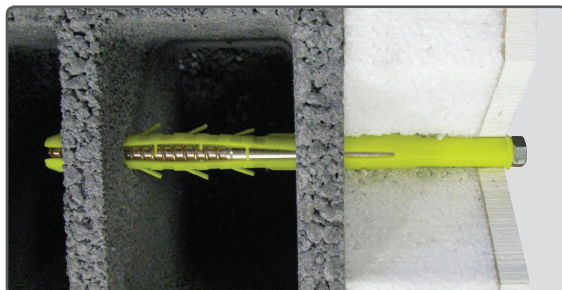
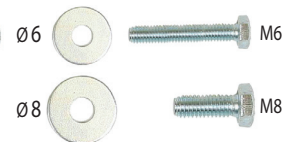
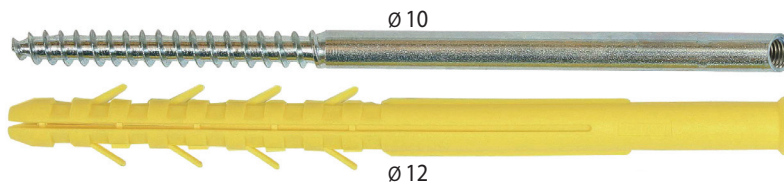

CARACTÉRISTIQUES

- ▶ Épaisseur maxi de la pièce à fixer : **3 mm**
- ▶ N'écrase pas la plaque de plâtre au serrage
- ▶ Ailettes anti-rotation
- ▶ Idéal matériaux creux : **expansion sur les 2 alvéoles du parpaing**

Ø x L (mm)	Référence	Condt	Surcondt	Matériaux pleins		Matériaux creux	
				Ep iso (mm)	Ancrage (mm)	Ep iso (mm)	Ancrage (mm)
12 x 200	A160470	Boîte de 20	-	120	80	60	140
	A855715	Sachet de 2	5 sachets	120	80	60	140
12 x 240	A160480	Boîte de 20	-	160	80	100	140
	A855718	Sachet de 2	5 sachets	160	80	100	140
12 x 240 + mèche 12 x 300	A855721	Sachet de 2	5 sachets	160	80	100	140

FIXATION CHAUDIÈRE MURALE



SANS DOUBLAGE

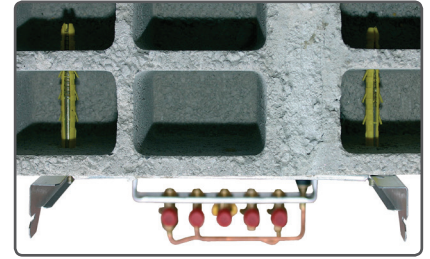
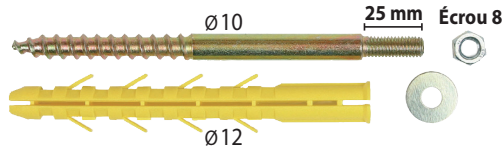
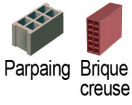

Ø x L (mm)	Référence	Condt	Surcondt
12 x 130	A160600	Sachet de 2	5 sachets

AVEC DOUBLAGE

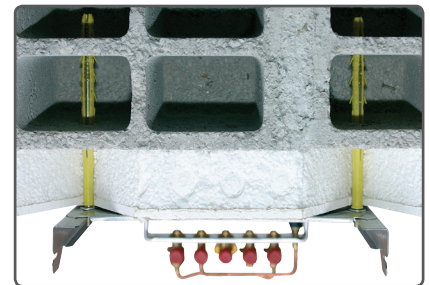
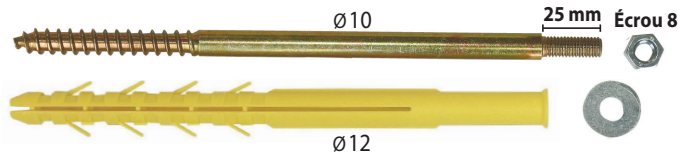
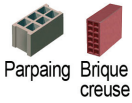

Ø x L (mm)	Référence	Condt	Surcondt
12 x 200	A160610	Sachet de 2	5 sachets
12 x 240	A160620		

FIXATION RADIATEUR

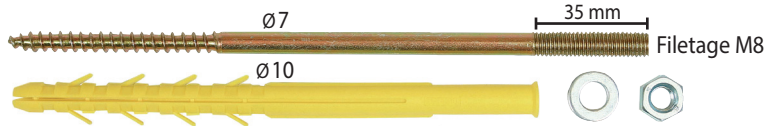
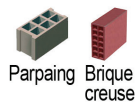

RADIATEUR LÉGER

Ø x L (mm)	Filetage	Référence	Condt	Surcondt	Ep doublage (mm)	Prof ancrage (mm)
10 x 160	M8	A150215	Boîte de 20	-	20	140
		A150200	Sachet de 2	5 sachets		
10 x 200	M8	A150231	Boîte de 20	-	60	140
		A150220	Sachet de 2	5 sachets		
10 x 240	M8	A150232	Boîte de 20	-	100	140
		A150222	Sachet de 2	5 sachets		
10 x 280	M8	A150234	Boîte de 20	-	140	140
		A150224	Sachet de 2	5 sachets		



RADIATEUR LOURD

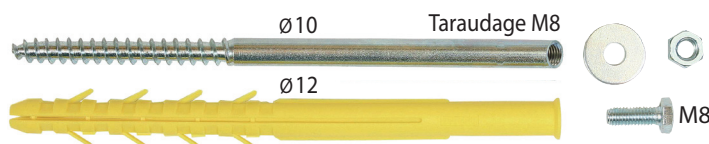

Ø x L (mm)	Taroudage	Référence	Condt	Surcondt	Ep iso (mm)	Prof ancrage (mm)
12 x 200	M8	A160150	Boîte de 20	-	60	140
		A160100	Sachet de 2	5 sachets		
12 x 240	M8	A160250	Boîte de 20	-	100	140
		A160200	Sachet de 2	5 sachets		
12 x 300	M8	A160270	Boîte de 20	-	160	140
		A160220	Sachet de 2	5 sachets		



CONSOLE POUR CHAUFFE-EAU PLAT SUR PLAFOND BÉTON LORSQUE LA POSE SUR CLOISONS EST IMPOSSIBLE



POSE HORIZONTALE

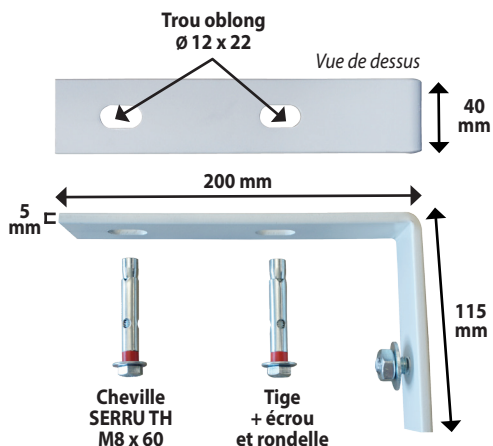

Désignation	Référence	Condt
Console pour POSE HORIZONTALE	A186360	La paire

POSE VERTICALE

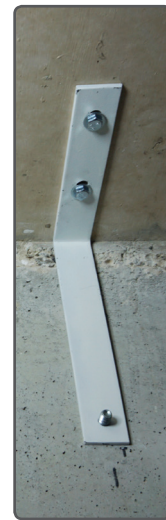
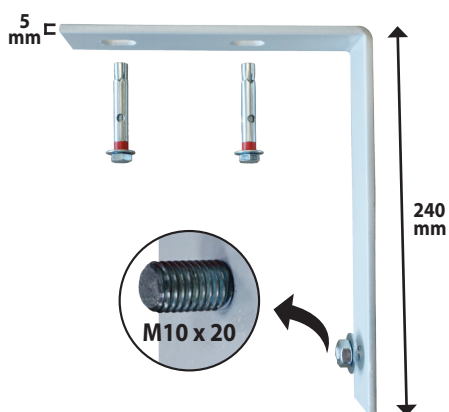

Désignation	Référence	Condt
Console pour POSE VERTICALE	A186370	La paire

FIXATION LAVABO



Parpaing Brique creuse

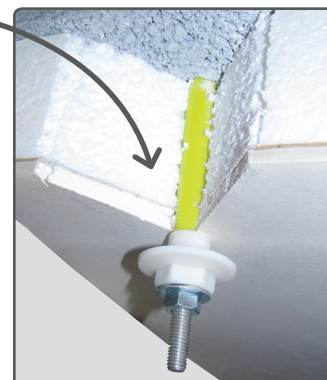
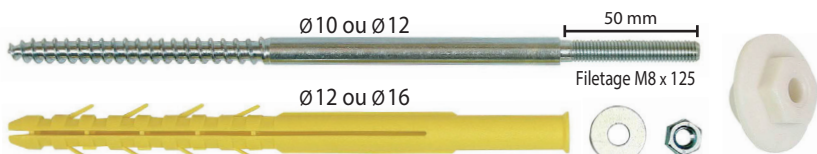

Ø x L (mm)	Référence	Condt	Surcondt	Ø vis	Ep. doublage (mm)	Prof ancrage (mm)
12 x 200	A150240	Sacnet de 2	5 sachets	10	60	140
12 x 240	A150250			10	100	140
16 x 300	A150252			12	160	140



CQLT & CQLT-R

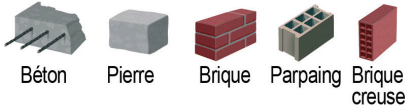

CQLT - TIREFOND TÊTE HEXAGONALE

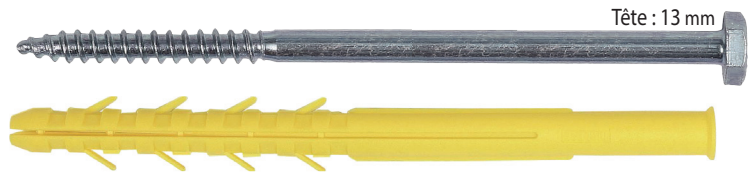
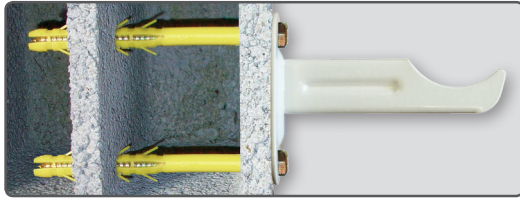

Tête : 13 mm

Ø (mm)	L (mm)	Référence	Condt	Matériaux pleins		Matériaux creux	
				Ep à fixer (mm)	Ancrage (mm)	Ep à fixer (mm)	Ancrage (mm)
Ø 10 tirefond Ø 7	80	A150140	Boîte de 25	3	80	-	-
	100	A150150		20	80	-	-
	120	A150160		40	80	-	-
	140	A150170		60	80	3	140
	160	A150180		80	80	20	140
	200	A150190		120	80	60	140
	240	A150192		Boîte de 15	160	80	100
280	A150193	200	80		140	140	
Ø 12 tirefond Ø 10	200	A090043	Boîte de 20	120	80	60	140
	240	A090046		160	80	100	140

CQLT-R - TIREFOND TÊTE HEXAGONALE EMPREINTE TORX (TÊTE AVEC RONDELLE)

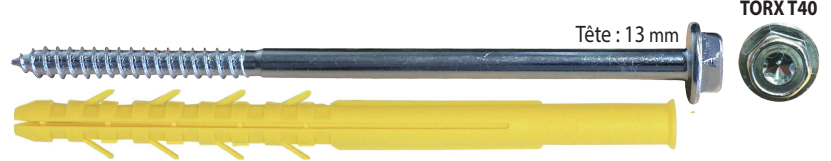
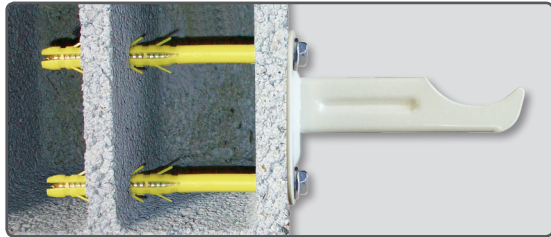

Tête : 13 mm

TORX T40

Ø (mm)	L (mm)	Référence	Condt	Matériaux pleins		Matériaux creux	
				Ep à fixer (mm)	Ancrage (mm)	Ep à fixer (mm)	Ancrage (mm)
Ø 10 tirefond Ø 7	80	A150095	Boîte de 25	3	80	-	-
	100	A150105		20	80	-	-
	120	A150115		40	80	-	-
	140	A150125		60	80	3	140
	160	A150135		80	80	20	140
	200	A150137		120	80	60	140

FIXATION ROBINET DE PUISAGE

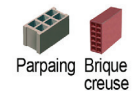

M8 M7

Ø 8 x 50

Matériaux	Ø x L (mm)	Référence	Condt	Surcondt	Ep iso (mm)	Prof ancrage (mm)
Creux	12 x 130	A150350	Sachet de 1	5 sachets	3	130
Creux + isolation	16 x 200	A150360			60	140
	16 x 240	A150370			100	140
	16 x 300	A150380			160	140

FIXATION SUPPORT DE CLIM

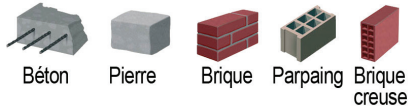

2 FIXATIONS HAUTES

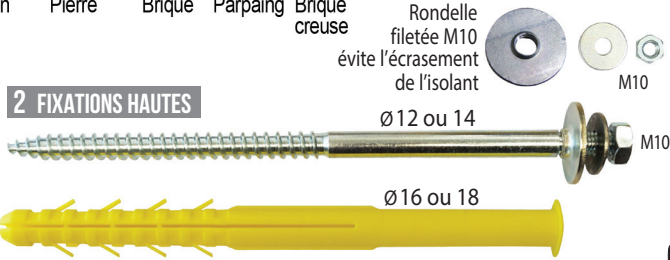

2 FIXATIONS BASSES



Kit complet!

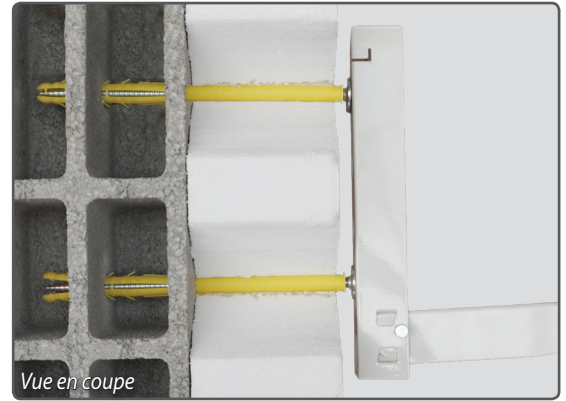

Ø x L cheville (mm)	Référence	Cond't	Surcond't	ISO mini - maxi (mm)	
				Matériaux creux	Matériaux pleins
16 x 240	A150320	Le Kit	5 sachets	80 - 110	130 - 160
18 x 300	A150330			120 - 170	170 - 220

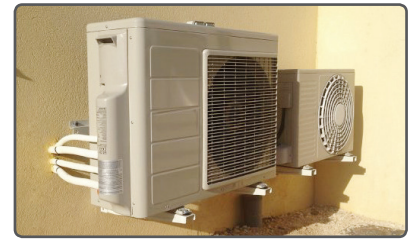

SUPPORT DE CLIMATISATION

CARACTÉRISTIQUES

- ▶ Silentblocs pour éviter le bruit dû aux vibrations
- ▶ Tous matériaux : bien penser à adapter sa fixation

L x H x P	Ep. acier	Référence	Cond't	Charge maximale
78 x 35 x 48	1,2	A162015	Unité	95 kg
78 x 40 x 48	1,5	A162020		115 kg
85 x 40 x 45	1,5	A162010		120 kg

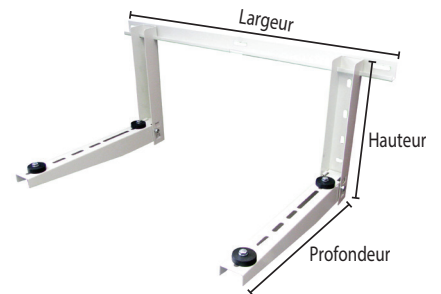

SUPPORT DE CLIMATISATION SOUDÉ

NOUVEAU

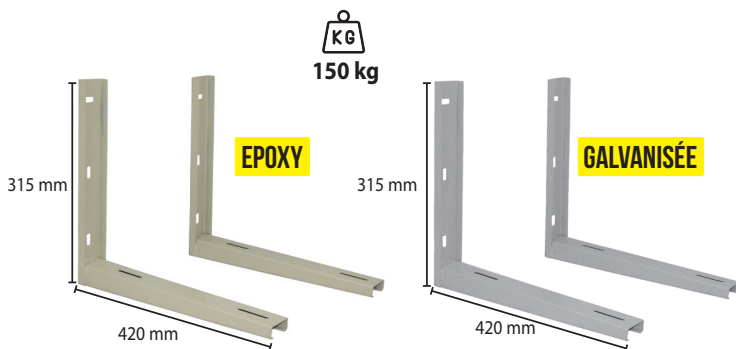

SILENTBLOCS
pour éviter le bruit dû aux vibrations

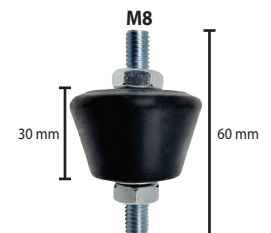

Finition	Référence	Cond't	Surcond't
Epoxy Beige	A162030	La paire	10 paires
Galvanisée	A162032		



Désignation	Référence	Cond't
Silentbloc	A162034	Sachet de 4

FIXATION DESCENTES D'EAUX PLUVIALES

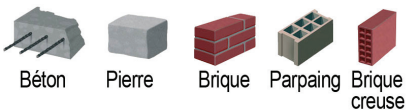

Conseil de perçage :
Matériaux creux : Ø10
Matériaux pleins : Ø11

CSTB
Le futur en construction



CARACTÉRISTIQUES

- Polyvalence tous matériaux
- Fixation possible avant ou après l'isolation
- Plus de ponts thermiques (PV CSTB sur demande)
Coefficient de transmission thermique: X= 0,006 W/K
- Collier toujours à la bonne distance

Nouveau 2 façons de visser :
- manuellement
- à l'aide d'une visseuse



Manuel

OU



PATTE À VIS LONGUE (SPÉCIALE I.T.E.)

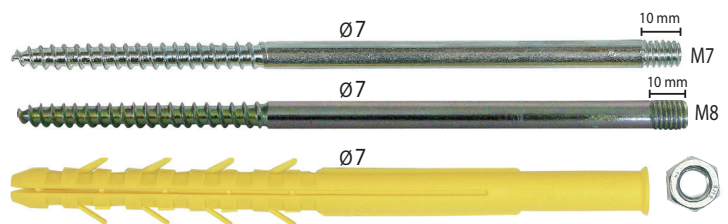
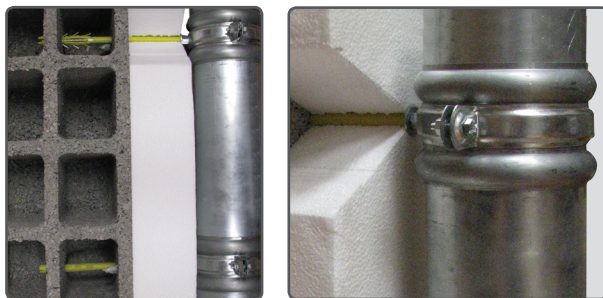

Filetage	Patte à vis L (mm)	Cheville Ø x L (mm)	Référence	Condt	ISO mini - maxi (mm)	
					Matériaux creux	Matériaux pleins
M7 Finition zinguée blanche	90	10 x 80	A140000	Boîte de 25	-	-
	130	10 x 120	A140010		-	-
	170	10 x 160	A140020		10 - 30	10 - 80
	210	10 x 200	A140030		40 - 70	90 - 120
	250	10 x 240	A140032		80 - 110	130 - 160
	290	10 x 280	A140033		120 - 150	170 - 200
	350	10 x 340	A140034		160 - 210	210 - 260
M8 Finition zinguée jaune	90	10 x 80	A140035		-	-
	130	10 x 120	A140040		-	-
	170	10 x 160	A140050		10 - 30	10 - 80
	210	10 x 200	A140060		40 - 70	90 - 120
	250	10 x 240	A140070		80 - 110	130 - 160
	290	10 x 280	A140075		120 - 150	170 - 200
	350	10 x 340	A140080		160 - 210	210 - 260

PATTE À VIS LONGUE - ALUMINIUM

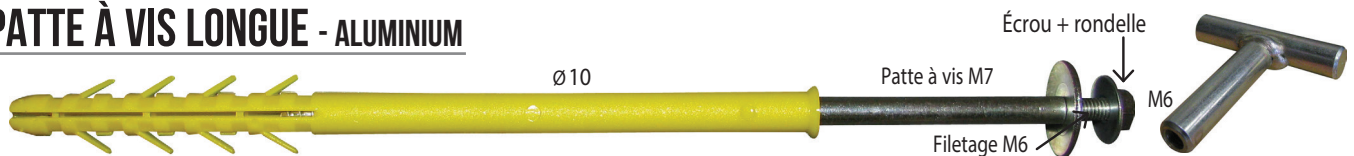

Filetage	Patte à vis L (mm)	Cheville Ø x L (mm)	Référence	Condt	ISO mini - maxi (mm)	
					Matériaux creux	Matériaux pleins
M6 Finition zinguée blanche	220	10 x 200	A140090	Boîte de 25	40 - 70	90 - 120
	260	10 x 240	A140095		80 - 110	130 - 160

FIXATION DAUPHIN

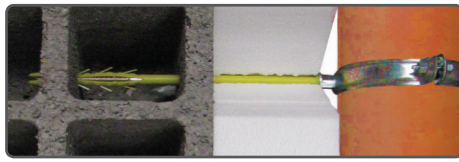

KG
ROBUSTE

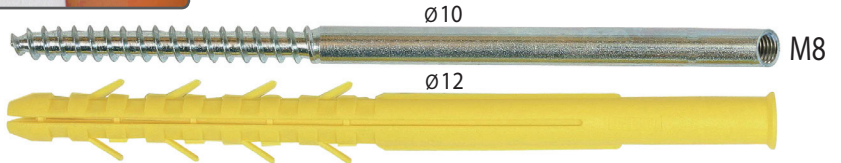

Taraudage	Cheville Ø x L (mm)	Référence	Condt	ISO mini - maxi (mm)	
				Matériaux creux	Matériaux pleins
M8 Finition zinguée blanche	12 x 240	A140120	Boîte de 10	80 - 110	130 - 160
		A140116	Sachet de 2		
	12 x 300	A140122	Boîte de 10	120 - 170	170 - 220
		A140118	Sachet de 2		



À adapter selon le taraudage du collier



Pour le vissage

COLLIER DESCENTE D'EAUX PLUVIALES

Taraudage	Ø (mm)	Référence	Condt	Taraudage	Ø (mm)	Référence	Condt
M7	40	A502005	Boîte de 25	M8	60	A502110	Boîte de 25
	60	A502010			80	A502115	
	80	A502015			90	A502118	
	90	A502020			100	A502120	
	100	A502023			110	A502123	
	110	A502025			125	A502125	
	125	A502030			140	A502130	
	140	A502035			160	A502135	
	160	A502040			180	A502138	
	180	A502043			200	A502140	
	200	A502045	250	A502143			



Finition galvanisée



VIS DOUBLE FILET DIRECTE BÉTON M8

- ▶ Résistance au feu
- ▶ Mise en place à l'aide d'une visseuse à chocs et d'une douille de 10

Filetage	Référence	Condt	Finition
M8	A244205	Boîte de 50	Zinguée



SANS CHEVILLE : facile et rapide !

NOUVEAU

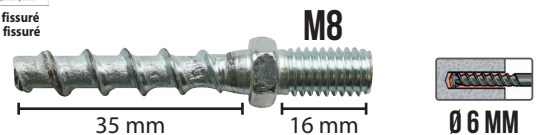

FIXATION SOLAIRE - POUR LA POSE DE PANNEAUX PHOTOVOLTAÏQUES

Filet BOIS - support : chevron

Ø x L (mm)	Référence	Condt	Finition
8 x 150	A211100	Boîte de 20	Inox A2

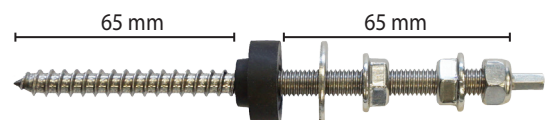

Filet MÉTRIQUE - support : structure métallique

Ø x L (mm)	Référence	Condt	Finition
8 x 130	A211195	Boîte de 20	Inox A2
8 x 200	A211200		



NOUVEAU

 Boîte solide,
empilable et réutilisable
Fabriquée en France

COLLIER SIMPLE

ZINGUÉE JAUNE

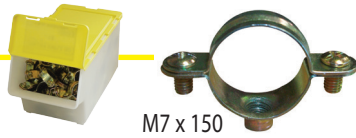

M7 x 150

Ø (mm)	Référence	Condt	Suremballage
10	A501005	Boîte de 100	1000 pièces
12	A501010		
14	A501015		
16	A501025		
18	A501030		
20	A501035		
22	A501040		
25	A501050		
26	A501055		
28	A501060		
32	A501070	Boîte de 50	500 pièces
40	A501100		
42	A501105		
50	A501120	Boîte de 25	
63	A501145		

ZINGUÉE BLANCHE



M7 x 150

Ø (mm)	Référence	Condt	Suremballage
10	A512014	Boîte de 100	1000 pièces
12	A512016		
14	A512018		
15	A512020		
16	A512022		
18	A512024		
20	A512026		
22	A512028		
24	A512030		
26	A512034		
28	A512036	Boîte de 50	500 pièces
32	A512040		
40	A512052		
42	A512054	Boîte de 25	
50	A512060		
63	A512070		

COLLIER SIMPLE ISO

ZINGUÉE JAUNE

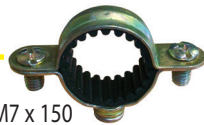

M7 x 150

Ø (mm)	Référence	Condt	Suremballage	
10	A501515	Boîte de 100	1000 pièces	
12	A501520			
14	A501525			
16	A501530			
18	A501535			
20	A501540			
22	A501545			
26	A501555			
28	A501560			
32	A501570			Boîte de 50
40	A501590			
42	A501595			
50	A501600	Boîte de 25	250 pièces	

ZINGUÉE BLANCHE



M7 x 150

Ø (mm)	Référence	Condt	Suremballage		
10	A512316	Boîte de 100	1000 pièces		
12	A512318				
14	A512320				
16	A512322				
18	A512324				
20	A512326				
22	A512328				
26	A512332			Boîte de 50	500 pièces
28	A512334				
32	A512338				
40	A512346				
42	A512348				

COLLIER DOUBLE

ZINGUÉE JAUNE



M7 x 150

Ø (mm)	Référence	Condt	Suremballage
12	A501335	Boîte de 50	500 pièces
14	A501340		
16	A501345		
18	A501350		
20	A501355		
22	A501360		
28	A501370	Boîte de 25	250 pièces

ZINGUÉE BLANCHE



M7 x 150

Ø (mm)	Référence	Condt	Suremballage
12	A512216	Boîte de 50	500 pièces
14	A512218		
16	A512222		
18	A512224		
20	A512226		
22	A512228		

COLLIER DOUBLE ISO



M7 x 150

ZINGUÉE JAUNE

Ø (mm)	Référence	Condt	Suremballage
12	A501820	Boîte de 50	500 pièces
14	A501825		
16	A501830		
18	A501835		
20	A501840		
22	A501845	Boîte de 25	250 pièces
28	A501860		



M7 x 150

ZINGUÉE BLANCHE

Ø (mm)	Référence	Condt	Suremballage
12	A512415	Boîte de 50	500 pièces
14	A512418		
16	A512420		
18	A512422		
20	A512424		
22	A512426	Boîte de 25	250 pièces
28	A512430		

ROSACE

Conique



Plate



ZINGUÉE JAUNE

Rosace	Ø (mm)	Référence	Condt	Suremballage
Conique	9 x 28	A503005	Boîte de 100	1000 pièces
	14 x 32	A503010		
	19 x 38	A503015		
	24 x 42	A503020		
	29 x 45	A503025		
Plate	25	A503105	Boîte de 100	1000 pièces
	32	A503110		
	40	A503115		

Conique



Plate



ZINGUÉE BLANCHE

Rosace	Ø (mm)	Référence	Condt	Suremballage
Conique	9 x 28	A512514	Boîte de 100	1000 pièces
	14 x 32	A512516		
	19 x 38	A512518		
	24 x 42	A512520		
	29 x 45	A512522		
Plate	25	A512530	Boîte de 100	1000 pièces
	32	A512540		
	40	A512550		

RALLONGE MÂLE / FEMELLE



ZINGUÉE JAUNE

Filetage	L (mm)	Référence	Condt	Suremballage
M7 x 150	10	A503510	Boîte de 100	1000 pièces
	15	A503515		
	20	A503520		
	30	A503530		
	40	A503540		
	50	A503545		
M8 x 125	20	A503620	Boîte de 100	1000 pièces
	30	A503630	Boîte de 50	500 pièces
	40	A503640		



ZINGUÉE BLANCHE

Filetage	L (mm)	Référence	Condt	Suremballage
M7 x 150	10	A512710	Boîte de 100	1000 pièces
	20	A512714		
	30	A512718		
	40	A512722		
	50	A512724		
	50	A512724		
M8 x 125	20	A512728	Boîte de 100	1000 pièces
	30	A512730	Boîte de 50	500 pièces
	40	A512732		

ENTRETOISE FEMELLE / FEMELLE



ZINGUÉE BLANCHE

Taraudage	L (mm)	Référence	Condt	Suremballage
M6	30	A503310	Boîte de 100	1000 pièces
	40	A503315		
M7	20	A503320		
	30	A503325		
M7	30	A503330		
	40	A503330		
M8	30	A503340		
	40	A503345		
M10	30	A503350		

RALLONGE HEXAGONALE

Longueur
20 mm



ZINGUÉE BLANCHE

Produit	Référence	Condt	Suremballage
Mâle M7 Femelle M8	A512740	Boîte de 100	1000 pièces
Mâle M8 Femelle M7	A512745		

PATTE À VIS BOIS - AVEC COLLERETTE

ZINGUÉE JAUNE



Filetage	L (mm)	Référence	Condt	Suremballage
M7 x 150	30	A504010	Boîte de 100	1000 pièces
	40	A504015		
	50	A504020		
	60	A504025		
	70	A504030		
M8 x 125	80	A504035		
	40	A504510		
	50	A504515		
	60	A504520		
	80	A504525		

ZINGUÉE BLANCHE



Filetage	L (mm)	Référence	Condt	Suremballage
M7 x 150	30	A512810	Boîte de 100	1000 pièces
	40	A512812		
	50	A512814		
	60	A512816		
	70	A512818		
M8 x 125	40	A512852		
	50	A512854		
	60	A512856		

PATTE À VIS AUTOPERCEUSE



Filetage	L (mm)	l (mm)	Finition	Référence	Condt
M7	20	5 mm	Zing. jaune	A504610	Boîte de 100
		Outil de pose	-	A504620	Unité
M8	20	10 mm	Zing. blanc	A504612	Boîte de 100
	20	15 mm	Zing. blanc	A504613	Boîte de 100
		Outil de pose	-	A504625	Unité

PATTE À VIS BOIS - GRANDE LONGUEUR

M8 SUR DEMANDE

Filetage	L (mm)	Référence	Condt
M7	130	A140160	Sachet de 10
	170	A140165	
	200	A140170	
	250	A140175	

GAMME SANITAIRE REVÊTEMENT BLANC

Désignation	Ø (mm)	Référence	Condt	Référence	Condt
COLLIER SIMPLE	16	A141570	Boîte de 50	A141571	Sachet de 10
	20	A141580		A141581	
	26	A141590		A141591	
	32	A141595		A141596	
	40	A141600		A141601	
COLLIER DOUBLE	16	A141655		A141656	
	20	A141660		A141661	
ROSACE CONIQUE	9 x 28	A141520		A141521	
	14 x 32	A141525		A141526	
	19 x 38	A141530		A141531	
ROSACE PLATE	32	A141550	A141551		

PATTE À VIS BOIS - SANS COLLERETTE

ACIER ZINGUÉ



Filetage	L (mm)	Référence	Condt
M8	50	A180642	Boîte de 100
	60	A180644	
	80	A180646	

INOX A4

Filetage	L (mm)	Référence	Condt
M8	50	A180900	Boîte de 20
	60	A180905	
	70	A180907	
M10	60	A180910	
	70	A180915	
	80	A180920	

PATTE À VIS "EASY"

VISSAGE + FACILE

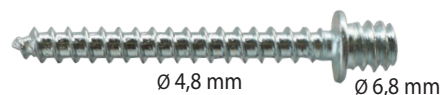

Filetage	L (mm)	Référence	Condt
M7	50	A181090	Boîte de 100

PATTE À VIS - INOX A4



Autres longueurs disponibles sur demande : nous sommes les fabricants !

Idéal pour les milieux corrosifs (cuisines, chambres froides, piscines, etc.)

INOX A4
ANTI-CORROSION

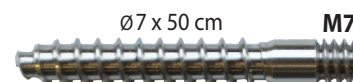

► À utiliser avec une cheville Ø 10

Filetage	L (mm)	Référence	Condt
M7	50	A180990	Sachet de 20

PATTE À VIS - POUR COLLIER ISOPHONIQUE

NOUVEAU



► À utiliser avec une cheville Ø 8

Filetage	L (mm)	Référence	Condt
M8	55	A180980	Boîte de 50

Collier simple



Collier double



NOUVEAU
GAMME SACHETS

Rosace conique



Rosace plate



CHEVILLE BRIK

SANS VIS



Dim. (mm)	Référence	Condt	Épaisseur (mm)	Ø perçage (mm)
M4 x 32	A506010	Boîte de 100	3 - 12	7
M4 x 46	A506015		16 - 24	7
M5 x 37	A506020		3 - 13	9
M5 x 52	A506023		3 - 16	9
M5 x 65	A506025		16 - 32	9
M6 x 37	A506030		3 - 13	10
M6 x 52	A506033		3 - 16	10
M6 x 65	A506035		16 - 32	10
M8 x 37	A506050		3 - 13	13
M8 x 55	A506053		3 - 16	13
M8 x 65	A506055	Boîte de 50	16 - 32	13

AVEC PATTE À VIS M7



Dim. (mm)	Référence	Condt	Épaisseur (mm)	Ø perçage (mm)
M4 x 35	A506210	Boîte de 100	8 - 14	7
M5 x 37	A506250		3 - 13	9
M5 x 52	A506255		3 - 16	9
M5 x 65	A506260		16 - 32	9
M6 x 37	A506270		3 - 13	10

AVEC VIS - EMPREINTE PH



Dim. (mm)	Référence	Condt	Épaisseur (mm)	Ø perçage (mm)
M4 x 32	A506110	Boîte de 100	3 - 12	7
M4 x 35	A506113		8 - 14	7
M4 x 46	A506115		16 - 24	7
M4 x 59	A506118		31 - 38	7
M5 x 37	A506120		3 - 13	9
M5 x 52	A506123		3 - 16	9
M5 x 65	A506125		16 - 32	9
M5 x 80	A506128		32 - 45	9
M6 x 37	A506130		3 - 13	10
M6 x 52	A506133		3 - 16	10
M6 x 65	A506135	Boîte de 50	16 - 32	10
M6 x 80	A506138		32 - 45	10
M8 x 37	A506150	Boîte de 100	3 - 13	13
M8 x 55	A506153	Boîte de 50	3 - 16	13
M8 x 65	A506155		16 - 32	13



KIT PINCE + CHEVILLES BRIK	Référence	Condt
1 pince + 10 chev. M4 x 32, 10 chev. M5 x 37 et 10 chev. M6 x 37	A991230	Unité

PINCES BRIK



Pince Brik N°1
A220105



Pince Brik N°2
A220106



Pince Brik N°3
A220108

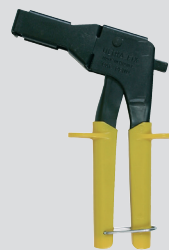

Pince Brik N°4
A220109



Pince Brik N°5
A220112



Pince Brik N°6
A220115

PATTE À VIS MÉTAUX - M7

► Finition zinguée blanche



Filetage x L (mm)	Référence	Condt
M4 x 40	A506630	Boîte de 100
M4 x 50	A506635	
M5 x 40	A506650	
M5 x 45	A506653	
M5 x 50	A506655	
M5 x 60	A506660	
M5 x 70	A506665	
M6 x 40	A506680	
M6 x 45	A506683	
M6 x 50	A506685	
M6 x 60	A506690	
M6 x 70	A506695	

VIS MÉTAUX - TÊTE RONDE

► Finition zinguée blanche

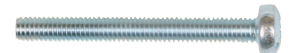

Filetage x L (mm)	Référence	Condt
M4 x 40	A506430	Boîte de 100
M4 x 53	A506435	
M4 x 67	A506440	
M5 x 40	A506445	
M5 x 43	A506450	
M5 x 57	A506455	
M5 x 67	A506460	
M5 x 82	A506465	
M6 x 43	A506480	
M6 x 57	A506485	
M6 x 67	A506490	
M6 x 82	A506495	



RACCORD DE JONCTION MÂLE - MÂLE



Zinguée
jaune

Filetage	Référence	Condt	Finition
Mâle M6	A140250	Sachet de 10	Zinguée jaune
Mâle M7	A140252	Boîte de 100	

Filetage	Référence	Condt	Finition
Mâle M6	A140260	Sachet de 10	Zinguée jaune
Mâle M8	A140261	Boîte de 100	

Filetage	Référence	Condt	Finition
Mâle M7	A140262	Sachet de 10	Zinguée jaune
Mâle M7	A140263	Boîte de 100	

Filetage	Référence	Condt	Finition
Mâle M7	A140264	Sachet de 10	Zinguée jaune
Mâle M8	A140265	Boîte de 100	

Filetage	Référence	Condt	Finition
Mâle M8	A140266	Sachet de 10	Zinguée jaune
Mâle M8	A140267	Boîte de 100	

NOUVEAU

Ø12



Zinguée
blanche

Ø12

Désignation	Référence	Condt	Finition
Mâle M7 Femelle M7	A140330	Boîte de 100	Zinguée blanche
	A140335	Boîte de 100	
	A140340	Boîte de 100	

Désignation	Référence	Condt	Finition
Mâle M8 Femelle M8	A140345	Boîte de 100	Zinguée blanche
	A140350	Boîte de 100	
	A140355	Boîte de 100	

RACCORD COUDÉ M7

- ▶ Permet de positionner les tuyaux debout
- ▶ Facilite les piquages

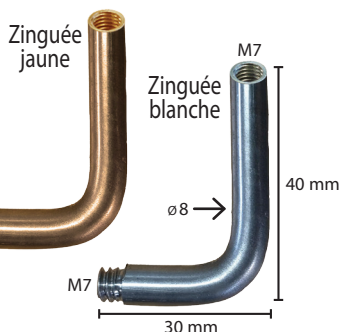
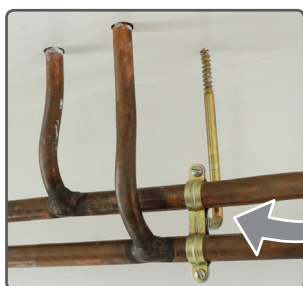

Filetage	Référence	Condt	Finition
Mâle M7 - Femelle M7	A140460	Sachet de 10	Zinguée blanche
	A140465	Sachet de 10	Zinguée jaune

RALLONGE MÂLE - FEMELLE



Zinguée
jaune



Zinguée
blanche

Filetage	Référence	Condt	Finition
Mâle M7 Femelle M6	A140410	Sachet de 10	Zinguée blanche
	A140400	Boîte de 100	

Filetage	Référence	Condt	Finition
Mâle M7 Femelle M8	A140300	Sachet de 10	Zinguée jaune
	A140310	Boîte de 100	

Filetage	Référence	Condt	Finition
Mâle M7 Femelle M8	A140312	Sachet de 10	Zinguée blanche
	A140314	Boîte de 100	

Filetage	Référence	Condt	Finition
Mâle M8 Femelle M7	A140316	Sachet de 10	Zinguée blanche
	A140318	Boîte de 100	

Filetage	Référence	Condt	Finition
Mâle M8 - Lg. 15 mm Femelle M6	A140324	Sachet de 10	Zinguée blanche
	A140326	Boîte de 100	

Filetage	Référence	Condt	Finition
Mâle M8 - Lg. 15 mm Femelle M7	A140320	Sachet de 10	Zinguée blanche
	A140322	Boîte de 100	

RALLONGE POUR COLLIER M 10



NOUVEAU

Filetage	Référence	Condt	Finition
Mâle M10 Femelle M7	A140370	Boîte de 50	Zinguée blanche

NOUVEAU

Filetage	Référence	Condt	Finition
Mâle M10 Femelle M8	A140380	Boîte de 50	Zinguée blanche

VIS SANITAIRE - TÊTE PLATE



- ▶ Empreinte TORX T30 fourni - Finition zinguée blanche

Ø x L (mm)	Référence	Condt
6 x 30	A150500	Boîte de 50
6 x 40	A150510	Boîte de 50
6 x 50	A150520	Boîte de 50
6 x 60	A150540	Boîte de 50

VIS DOUBLE FILET Ø7



- ▶ Pour la fixation de WC et bidet

Clé plate de 6

L_F

Ø x L (mm)	Référence	Condt	L _F (mm)
M8 x 80	A181010	Boîte de 25	30
M8 x 90	A181012	Boîte de 25	40
M8 x 110	A181015	Boîte de 25	60
M8 x 120	A181020	Boîte de 25	70
M10 x 80	A181030	Boîte de 20	30
M10 x 120	A181040	Boîte de 20	70
M12 x 140	A181050	Boîte de 20	90

GAMME SACHET LIBRE SERVICE - ZINGUÉE BLANCHE

Désignation	Référence	Condt	Surcondt
Vis sanitaire zinguée	Ø 6 x 30	A509772	5 sachets
	Ø 6 x 40	A509775	
	Ø 6 x 50	A509780	
Collier simple	Ø 10	A509795	
	Ø 12	A509800	
	Ø 14	A509803	
	Ø 16	A509806	
	Ø 18	A509808	
	Ø 20	A509810	
	Ø 22	A509812	
	Ø 25	A509815	
	Ø 28	A509818	
	Ø 32	A509821	
Collier double	Ø 40	A509824	
	Ø 50	A509829	
	Ø 12	A509833	
	Ø 14	A509836	
	Ø 16	A509839	
Collier simple ISO	Ø 18	A509841	
	Ø 22	A509845	
	Ø 10	A509860	
	Ø 12	A509862	
Collier double ISO	Ø 14	A509863	
	Ø 16	A509866	
	Ø 18	A509869	
	Ø 20	A509872	
	Ø 22	A509875	
	Ø 28	A509877	
Collier double ISO	Ø 12	A509878	
	Ø 14	A509879	
	Ø 16	A509880	
	Ø 18	A509881	
	Ø 22	A509883	
Cheville collerette	Ø 28	A509885	
	Ø 8	A509935	

Désignation	Référence	Condt	Surcondt
Rosace conique	Ø 9	A509887	Sachet de 20
	Ø 14	A509890	
	Ø 19	A509891	
	Ø 25	A509893	
Rosace plate	Ø 25	A509894	5 sachets
Rallonge MF	M7 x 10	A509906	
	M7 x 20	A509908	
	M7 x 30	A509911	
	M7 x 40	A509914	
	M8 x 20	A509916	
	M8 x 30	A509918	
Patte à vis bois	M8 x 40	A509919	
	M7 x 30	A509921	
	M7 x 40	A509923	
	M7 x 50	A509926	
Patte à vis métaux	M7 x 60	A509928	
	M8 x 40	A509931	
	M8 x 60	A509933	
Entretoise	M5 x 50	A509975	
	M5 x 60	A509976	
	M6 x 50	A509980	
Cheville Brik	M6 x 60	A509982	
	M6 x 30	A509895	
	M7 x 30	A509896	
Cheville Brik + patte à vis	M8 x 30	A509897	
	M10 x 30	A509898	
	M5 x 37	A509952	
Cheville Brik + vis	M5 x 52	A509954	
	M6 x 37	A509958	
	M6 x 52	A509959	
Cheville Brik + vis	M5 x 37	A509942	
	M5 x 52	A509944	
	M5 x 37	A509962	
Cheville Brik + vis	M5 x 52	A509964	
	M6 x 37	A509968	
Cheville Brik + vis	M6 x 37	A509968	
	M6 x 52	A509969	



PATTE À GLACE RESSORT

► Pour la fixation de miroir



Cheville Ø x L (mm)	Référence	Condt	Contenu sachet
6 x 30	A186405	Sachet de 4	4 chevilles Ø6 4 vis tête fraisée Ø4 2 pattes fixation hautes 2 pattes fixations basses

CACHE-TROU Ø50 MM - POUR LAVABO OU BIDET

► Pas besoin d'outil pour serrer grâce au **papillon** qui permet également d'assurer une **bonne étanchéité** !



Référence	Contenu sachet	Finition
A500650	1 vis laiton M6 x 68 1 écrou papillon laiton M6 1 rondelle Ø23 1 rondelle caoutchouc 1 tête en laiton chromé	Laiton chromé

FIXATION WC ET BIDET - RÉASSORT DE 5 SACHETS

AVEC ÉCROU BORGNE

Ø x L (mm)	Référence	Condt	Contenu sachet
6 x 70	A500170	Sachet de 2	2 vis double filets Ø 6 Inox 2 chevilles collerettes Ø 8
6 x 80	A500180		2 écrous borgnes chromés Ø 6 2 fourreaux de protection nylon

Sachet zippé refermable

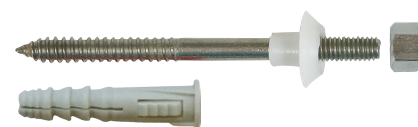

DOUBLE CAPUCHON

Ø x L (mm)	Référence	Condt	Contenu sachet
6 x 60	A500190	Sachet de 2	2 vis TH Ø 6 Inox 2 chevilles collerettes Ø 8
6 x 70	A500200		2 fourreaux de protection nylon 2 capuchons chromés
6 x 80	A500210		2 capuchons blancs

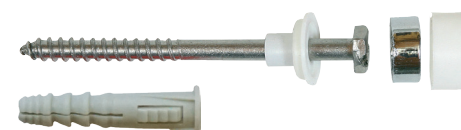

CHEVILLE LONGUE + DOUBLE CAPUCHON

Ø x L (mm)	Référence	Condt	Contenu sachet
6 x 60	A500220	Sachet de 2	2 vis TH Ø 6 Inox 2 chevilles nylon Ø 8
6 x 70	A500230		2 capuchons chromés 2 capuchons blancs
6 x 80	A500240		



CHEVILLE ALPHAGRIP - RÉASSORT DE 5 SACHETS

Ø x L (mm)	Référence	Condt	Contenu sachet
8 x 37	A500635	Sachet de 2	2 chevilles en métal 2 rondelles nylon excentrées
8 x 55	A500640		2 tiges filetées Ø 8 x 110 2 écrous filetés + 2 rondelles
8 x 65	A500645		

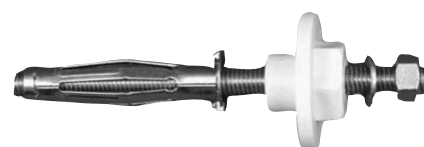

CARACTÉRISTIQUES

- ▶ Expanser la cheville avec une pince brik
- ▶ Cheville idéale pour la plaque de plâtre

FIXATION MULTI-USAGE - RÉASSORT DE 5 SACHETS

Ø x L (mm)	Référence	Condt	Contenu sachet
8 x 90	A500555	Sachet de 2	2 plaquettes filetées 2 écrous filetés + 2 rondelles
8 x 110	A500560		
8 x 140	A500565		
10 x 110	A500575		
10 x 140	A500580		

CARACTÉRISTIQUES

- ▶ Plaquette filetée pour la fixation d'éléments lourd
- ▶ Applications : meubles de cuisine, chauffe-eau, chaudières murales...



Plaquette filetée

FIX-TOUT - RÉASSORT DE 5 SACHETS

Ø x L (mm)	Référence	Condt	Contenu sachet
10 x 70	A500585	Boîte de 10	2 tirefonds ø10 x 70 2 chevilles nylon ø12 2 rondelles



FIXATION LAVABO ET WC SUSPENDUS - RÉASSORT DE 5 SACHETS

Ø x L (mm)	Référence	Condt	Contenu sachet
8 x 90	A500010	Sachet de 2	2 chevilles ø12 2 vis double filets ø8 2 écrous nylon ø8 à collerette filetés
8 x 110	A500020		
10 x 100	A500030		2 chevilles ø14 2 vis double filets ø10 2 écrous nylon ø10 à collerette filetés
10 x 120	A500040		
10 x 140	A500050		

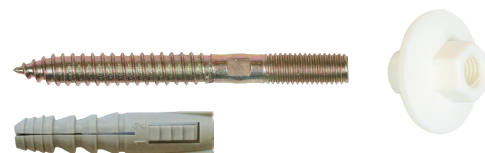

AVEC RONDELLE EXCENTRÉE

Ø x L (mm)	Référence	Condt	Contenu sachet
8 x 90	A500080	Sachet de 2	2 chevilles ø12 2 vis double filets ø8 2 rondelles nylon excentrées ø8 2 écrous + 2 rondelle zingués blanc
8 x 110	A500090		
10 x 100	A500100		2 chevilles ø14 2 vis double filets ø10 2 rondelles nylon excentrées ø10 2 écrous filetés + 2 rondelles zingués blanc
10 x 120	A500110		
10 x 140	A500120		

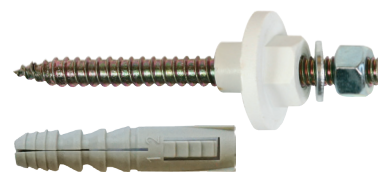

FIXATION LAVABO - RÉASSORT DE 5 SACHETS

Ø x L (mm)	Référence	Condt	Contenu sachet
8 x 90	A500500	Sachet de 2	2 plaquettes filetées 2 rondelles nylon excentrées (ø8 ou ø10) 2 écrous filetés + 2 rondelles zingués blanc
8 x 110	A500505	Sachet de 2	
8 x 140	A500510	Sachet de 2	
10 x 110	A500520	Sachet de 2	
10 x 140	A500525	Sachet de 2	

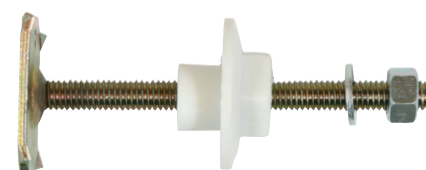

Plaquette filetée

FIXATION BALLON D'EAU CHAUDE - RÉASSORT DE 5 SACHETS

SANS PLAQUETTE FILETÉE

Ø x L (mm)	Référence	Condt	Contenu sachet
10 x 120	A500150	Sachet de 2	4 vis double filets ø10 4 chevilles ø14 4 écrous nylon plats ø10 filetés 4 écrous + 4 rondelles zingués
10 x 140	A500160		

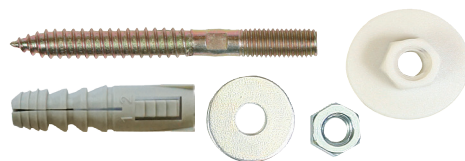

AVEC PLAQUETTE FILETÉE

Ø x L (mm)	Référence	Condt	Contenu sachet
10 x 140	A500530	Sachet de 2	4 plaquettes filetées 4 écrous nylon plats ø10 filetés

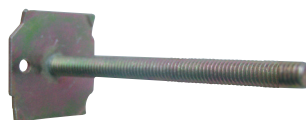



Bien penser à adapter les fixations en fonction du support !

SUPPORT DE RADIATEUR À VISSER

POUR RADIATEUR EN FONTE TYPE RIDEAU

L (mm)	Référence	Condt	Finition	l (mm)	H (mm)
120	A186010	Boîte de 10	Epoxy Blanc	90	100
135	A186015			105	100

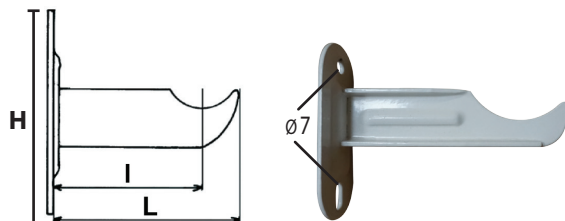

POUR RADIATEUR EN FONTE TYPE TRADITIONNEL

L (mm)	Référence	Condt	Finition	l (mm)	H (mm)
140	A186020	Boîte de 10	Epoxy Blanc	100	100
180	A186025			140	100

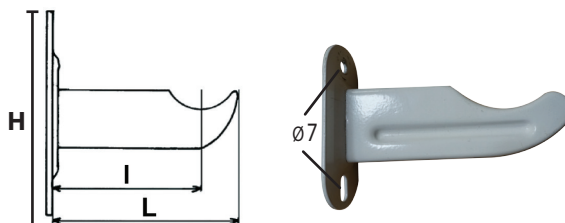

SUPPORT DE RADIATEUR À SCELLER

POUR RADIATEUR EN FONTE TYPE TRADITIONNEL

L (mm)	Référence	Condt	Finition	l (mm)	H (mm)
260	A186080	Boîte de 30	Zinguée blanche	225	40
290	A186085			255	40

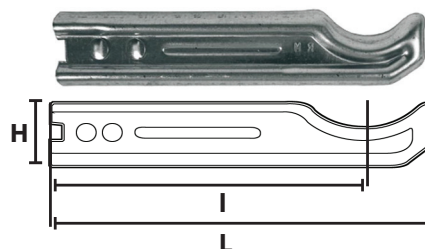

FIXATION RADIATEUR ACIER

Type	Référence	Condt	L (mm)	H x l platine (mm)	Finition
Embase carrée	A186090	Boîte de 10	50	40 x 35	Zinguée blanche
Embase triangulaire	A186100		100	65 x 55	

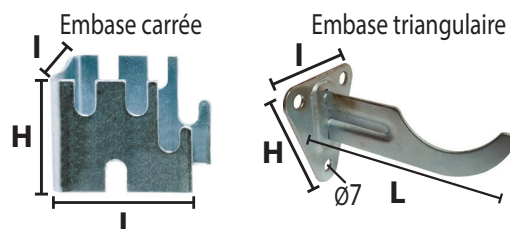

SUPPORT RADIATEUR TUBE À FRAPPER

Type	Référence	Condt	L (mm)
Support radiateur tube à frapper	A186110	Boîte de 12	240
Pattes de fixations	A186112	Boîte de 6 sachets	-



PLAQUETTE DE FIXATION D'ÉLÉMENTS SANITAIRES

CARACTÉRISTIQUES

- ▶ Meilleure tenue (seulement 2 trous)
- ▶ Réglable grâce aux deux lumières
- ▶ Tous matériaux : bien penser à adapter sa fixation

Désignation	Référence	Condt	Finition
Plaquette sanitaire	A150236	Boîte de 20	Zinguée blanche
	A150238	Sachet de 2	

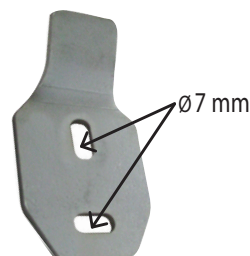

CONSOLE POUR LAVABO COLLECTIF - RÉGLABLE



- ▶ Réglable pour s'adapter à tous les lavabos :
 - **NORMALE** : de 180 à 255 mm
 - **LARGE** : de 245 à 340 mm
- ▶ Livrée avec accessoires

FINITION EPOXY BLANC

2 possibilités de pattes fournies dans chaque boîte (selon la marque) :

- ▶ x 2 angle à 90°
- ▶ x 2 angle à 120°

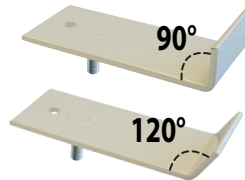

Désignation	Finition	Référence	Condt
Console NORMALE pour lavabo collectif	Epoxy blanche	A186300	La paire
Console LARGE pour lavabo collectif		A186302	

CONSOLE EN ACIER

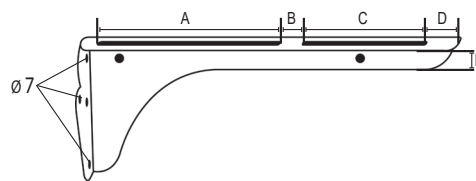

CONTENU D'UN SACHET

- ▶ 2 consoles
- ▶ 2 tiges filetées $\varnothing 5$
- ▶ 2 vis TF 4 x 16
- ▶ 6 vis bois TR $\varnothing 6$ x 40
- ▶ 2 butées rondes caoutchouc
- ▶ 2 butées tête de gendarme
- ▶ 2 bascules
- ▶ 4 écrous acier $\varnothing 5$
- ▶ 2 écrous acier $\varnothing 4$
- ▶ 6 chevilles $\varnothing 8$ x 40
- ▶ 2 rondelles caoutchouc

L (mm)	Finition	Référence	Condt	Surcondt	A	B	C	D	E
210	Zinguée blanche	A186145	La paire	Boîte de 5 paires	95	15	70	15	25
250		A186150			98	15	68	54	25

CONSOLE EN ALUMINIUM

L (mm)	Finition	Référence	Condt	Surcondt	H (mm)	A (mm)	D (mm)
220	Alu	A186210	La paire	Boîte de 10 paires	155	113	64
280		A186220			155	113	124

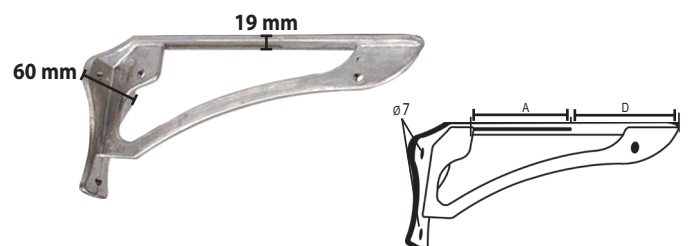

RONDELLE

FUMISTERIE

Filetage	Ø (mm)	Référence	Condt
M8	42	A150300	Boîte de 20

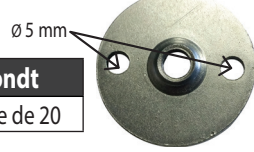

NYLON

Filetage	Ø (mm)	Référence	Condt
M8	45	A130340	Boîte de 100
	45	A130350	Vrac 1000

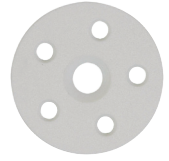

FILETÉE

Filetage	Ø (mm)	Référence	Condt
M6	30	A150260	Boîte de 20
M8	30	A150270	
M10	35	A150280	
M12	41	A150290	Boîte de 15



CUVETTE

Filetage	Ø (mm)	Référence	Condt
M5	24	A270230	Boîte de 200
M6	30	A270235	
M8	30	A270240	Boîte de 100
	70	A270245	



M5, M6 et M8 x 30



M8 x 70

MÈCHE FAÏENCE

- Perçage sans percussions
- Permet de percer sans dérapier
- 4 taillants

Ø x L (mm)	Référence	Condt	Ø x L (mm)	Référence	Condt
4 x 65	A411010	Unité	8 x 70	A411050	Unité
5 x 65	A411020				
6 x 65	A411030				
7 x 70	A411040				
			12 x 80	A411070	
		16 x 100	A411090		

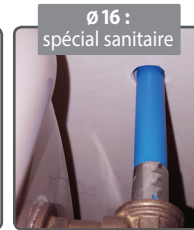
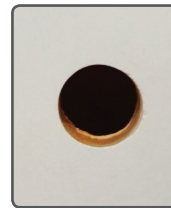

Ø 16 : spécial sanitaire



Humidifiez la mèche pendant le perçage

Ø 16



OUTIL DIAMANTÉ - IDÉAL POUR LE PERÇAGE DU CARRELAGE, GRANIT, MARBRE, GRÈS ÉMAILLÉ...

- Perçage à sec
- Perçage facile, précis et propre
- Perçage sans percussions

FORET DIAMANT - POUR PERÇEUSE OU VISSEUSE



Ø (mm)	Référence	Condt
6	A104110	Unité
8	A104115	
10	A104120	
14	A104130	
16	A104135	

TREPAN DIAMANT - POUR MEULEUSE

Ø (mm)	Référence	Condt
6	A104001	Unité
8	A104002	
10	A104003	
12	A104004	
14	A104005	
20	A104010	
27	A104015	
30	A104020	
35	A104025	
45	A104035	
68	A104050	



DISQUE ABRASIF

CARACTÉRISTIQUES

- Diamètre du disque : Ø 125 mm
- Épaisseur de la couronne : 1,0 mm
- Alésage : Ø 22,23 mm

➔ ACIER
➔ INOX

Désignation	Référence	Condt
DISQUE ABRASIF Ø 125 x 1,0 mm	A105050	Bte métal. de 10
	A105051	Carton de 200
	A105052	Minibox de 10 Btes



COLLIER FLIP

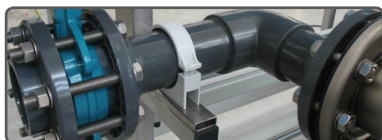

CARACTÉRISTIQUES

- ▶ Démontable ▶ Résistance : acidité - eau de mer - oxydation
- ▶ Caoutchouc EPDM :
 - anti vibratile et bruit
 - stabilisé UV
 - tenue aux températures de -20°C à 80°C
- ▶ Utilisations : bateau, piscine, chambre froide, milieu agricole, cave à vin, cuisine industrielle...



COLLIER FLIP ISO

Ø (mm)	Taraudage	Référence	Condt	Éq. pouce
16 - 18	M8	A181200	Boîte de 30	3/8"
20 - 24	M8	A181210		1/2"
25 - 30	M8	A181215		3/4"
32 - 36	M8	A181220	Boîte de 25	1"
38 - 44	M8	A181225	Boîte de 20	1" 1/4
44 - 50	M8/M10	A181230		1" 1/2
56 - 62	M8/M10	A181235		2"
74 - 80	M8/M10	A181240	Boîte de 10	2" 1/2
84 - 90	M8/M10	A181245		3"
100 - 110	M10	A181250		3" 1/2
125 - 135	M10	A181255		4"

COLLIER FLIP-R ISO

Ø (mm)	Référence	Condt	Éq. pouce
20 - 24	A181310	Boîte de 30	1/2"
25 - 30	A181315		3/4"
32 - 36	A181320	Boîte de 25	1"
38 - 44	A181325	Boîte de 20	1" 1/4
44 - 50	A181330		1" 1/2
56 - 62	A181335		2"
74 - 80	A181340	Boîte de 10	2" 1/2
84 - 90	A181345		3"

COLLIER TWIST CLIP - FIXATION DE TUYAUX SUR TIGES FILETÉES ET RAILS

POUR TIGE FILETÉE M6 ET M7

Ø (mm)	Éq. pouce	Référence	Condt	Surcondt	Plage de serrage
32	1"	A181400	Sachet de 15	5 sachets	30 - 34
40	1" 1/4	A181405			38 - 42

POUR TIGE FILETÉE M8 - TUYAU SIMPLE

Ø (mm)	Éq. pouce	Référence	Condt	Surcondt	Plage de serrage
32	1"	A181410	Sachet de 15	5 sachets	30 - 34
40	1" 1/4	A181420			38 - 42
55	2"	A181425			53 à 57

POUR TIGE FILETÉE M8 - MULTI-TUYAU

Ø (mm)	Éq. pouce	Référence	Condt	Surcondt	Plage de serrage
54 + 38 + 28	-	A181460	Sachet de 5	5 sachets	-

POUR RAIL LARGEUR 41 MM

POUR TUYAU Ø 18 À Ø 20 MM ①

Ø (mm)	Éq. pouce	Référence	Condt	Surcondt	Plage de serrage
20	1/2"	A181480	Sachet de 15	5 sachets	19 - 21

POUR CÂBLES ÉLECTRIQUES Ø 6, Ø 8 OU Ø 10 MM ②

Ø (mm)	Éq. pouce	Référence	Condt	Surcondt	Plage de serrage
6	-	A181490	Sachet de 15	5 sachets	-

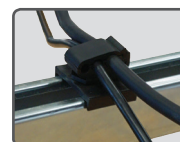
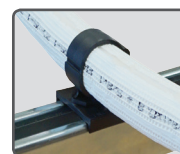
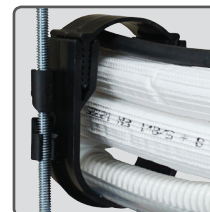
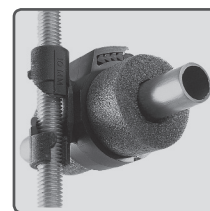

COLLIER I.N.G. 2 VIS



EN ACIER ZINGUÉ - M8/M10

Ø (mm)	Éq. pouce	Référence	Condt
14 - 18	3/8"	A180030	Boîte de 25
20 - 24	1/2"	A180040	
23 - 28	3/4"	A180050	
32 - 35	1"	A180060	
39 - 44	1" 1/4	A180070	Boîte de 20
44 - 53	1" 1/2	A180080	
53 - 58	-	A180085	
56 - 65	2"	A180090	
62 - 69	-	A180095	
76 - 84	2" 1/2	A180100	Boîte de 15
82 - 92	3"	A180110	
99 - 105	3" 1/2	A180120	
107 - 115	-	A180125	Boîte de 10
113 - 118	4"	A180130	
116 - 126	-	A180140	Boîte de 5
133 - 140	5"	A180150	
159 - 168	6"	A180160	
207 - 215	-	A180165	

EN INOX A2 - M8

Ø (mm)	Éq. pouce	Référence	Condt
14 - 18	3/8"	A180700	Boîte de 25
20 - 24	1/2"	A180710	
23 - 28	3/4"	A180720	
32 - 35	1"	A180730	
39 - 44	1" 1/4	A180740	Boîte de 20
44 - 53	1" 1/2	A180750	
56 - 65	2"	A180760	
76 - 84	2" 1/2	A180770	
82 - 92	3"	A180780	
99 - 105	3" 1/2	A180790	Boîte de 10
113 - 118	4"	A180795	
116 - 126	-	A180800	
133 - 140	5"	A180810	Boîte de 5
159 - 168	6"	A180820	
207 - 215	-	A180830	

COLLIER ISOLÉ - OUVERTURE RAPIDE



CARACTÉRISTIQUES

- ▶ Isolation phonique en caoutchouc EPDM
- ▶ Isolation phonique selon DIN 4109
- ▶ Résistance au feu classe B2 selon DIN 4102
- ▶ Caoutchouc EPDM :
 - sans chlore
 - stabilisé UV
 - tenue aux températures de -50°C à 110°C



1 VIS - M8 - ACIER ZINGUÉ

Ø (mm)	Éq. pouce	Référence	Condt
12 - 16	1/4"	A180475	Boîte de 10
15 - 19	3/8"	A180479	
20 - 23	1/2"	A180481	
26 - 30	3/4"	A180483	
31 - 36	1"	A180485	Boîte de 5
40 - 43	1" 1/4	A180487	
48 - 53	1" 1/2	A180489	

2 VIS - M8/M10 - ACIER ZINGUÉ



Ø (mm)	Éq. pouce	Référence	Condt
12 - 16	1/4"	A181500	Boîte de 25
15 - 19	3/8"	A181505	
20 - 24	1/2"	A181510	
26 - 30	3/4"	A181515	
31 - 36	1"	A181520	Boîte de 20
40 - 46	1" 1/4	A181525	
48 - 53	1" 1/2	A181530	
54 - 59	-	A181532	
60 - 64	2"	A181535	
72 - 83	2" 1/2	A181540	Boîte de 15
87 - 92	3"	A181545	
102 - 116	4"	A181550	

COLLIER ISOLÉ 2 VIS - M8/M10 - ACIER ZINGUÉ

Ø (mm)	Éq. pouce	Référence	Condt
12 - 15	1/4"	A180280	Boîte de 25
15 - 19	3/8"	A180290	
20 - 24	1/2"	A180300	
23 - 28	3/4"	A180310	
31 - 36	1"	A180320	Boîte de 20
38 - 44	1" 1/4	A180330	
44 - 50	1" 1/2	A180340	
54 - 58	-	A180350	
59 - 65	2"	A180360	
62 - 67	-	A180370	

Ø (mm)	Éq. pouce	Référence	Condt
74 - 80	2" 1/2	A180380	Boîte de 20
83 - 93	3"	A180390	Boîte de 15
95 - 103	-	A180400	Boîte de 10
108 - 118	4"	A180420	Boîte de 5
124 - 130	-	A180430	
132 - 143	5"	A180440	Boîte de 5
159 - 169	6"	A180450	
198 - 202	-	A180460	
216 - 225	8"	A180470	



L'isolant résiste de -40°C à 110°C

COLLIER ISOPHONIQUE SÉRIE LOURDE M8 - ISOLANT ÉPAIS

Ø (mm)	Éq. pouce	Référence	Condt	Plage de serrage
15 - 21	1/2"	A181110	Boîte de 25	20 - 25
20 - 27	3/4"	A181115		26 - 30
26 - 34	1"	A181120		32 - 36
33 - 42	1" 1/4	A181125	Boîte de 20	38 - 43
40 - 49	1" 1/2	A181130		47 - 51
50 - 60	2"	A181135		60 - 64
80 - 90	3"	A181140		87 - 92

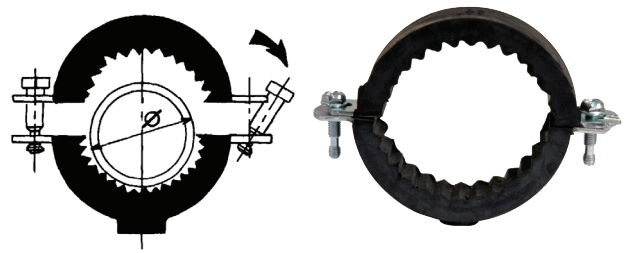

COLLIER DE SERRAGE

EN ACIER ZINGUÉ - LARGEUR 8 MM

Ø (mm)	Référence	Condt
8 - 12	A502305	Sachet de 10
10 - 16	A502310	
14 - 24	A502313	
18 - 28	A502315	
24 - 36	A502318	
32 - 52	A502320	
40 - 60	A502325	
47 - 67	A502328	

EN INOX A2 - LARGEUR 8 MM

Ø (mm)	Référence	Condt
10 - 16	A502613	Sachet de 10
14 - 24	A502615	
18 - 28	A502618	
24 - 36	A502620	
32 - 52	A502623	Sachet de 5
40 - 60	A502625	
47 - 67	A502628	

EN ACIER ZINGUÉ - LARGEUR 14 MM

Ø (mm)	Référence	Condt
14 - 22	A502410	Sachet de 10
18 - 28	A502413	
24 - 36	A502415	
32 - 52	A502418	
40 - 60	A502420	
47 - 67	A502423	
62 - 82	A502425	Sachet de 5
77 - 97	A502428	
92 - 112	A502430	

EN INOX A2 - LARGEUR 14 MM

Ø (mm)	Référence	Condt
14 - 22	A502710	Sachet de 5
18 - 28	A502713	
24 - 36	A502715	
32 - 52	A502718	
40 - 60	A502720	
47 - 67	A502723	
62 - 82	A502725	
77 - 97	A502728	
92 - 112	A502730	

Surcondt : 5 sachets



COLLIER DE LIAISON POUR ISOLATION SOLAIRE

► Pour fixer les gaines de capteurs solaires ou de climatiseurs

Référence	Condt	Finition	H (mm)	L (mm)	F (mm)
A180190	Boîte de 5	Zinguée blanche	32 à 54	76	20

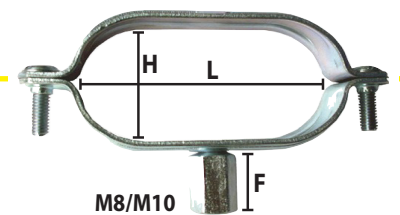

BANDE SANS FIN - 3M

Largeur (mm)	Finition	Référence	Nombre de têtes	Condt
8	Acier	A502910	8	Carton de 10
	Inox A2	A502940	8	
14	Acier	A502930	6	
	Inox A2	A502950	6	



COLLIER AÉRAULIQUE

Ø x L (mm)	Référence	Finition	Condt
9 x 910	A280350	Blanche	Sachet de 100
9 x 1200	A280355		

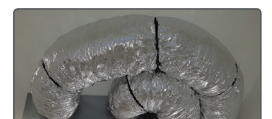

CHEVILLE POLYSTYRÈNE

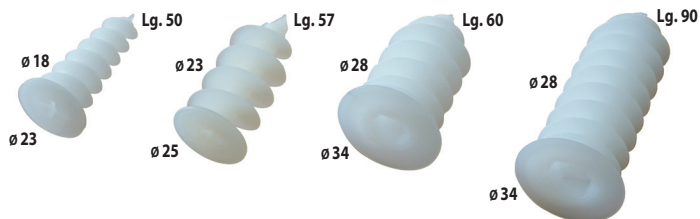

Ø x L (mm)	Référence	Condt	Embout	Taille vis
23 x 50	A136010	25	PH n°3	Ø 3-4 x 25mm
23 x 50 + Vis TF	A136055		PH n°3	Ø 4 x 40mm
23 x 50 + PAV M7	A136065		PH n°3	PAV. M7
25 x 57	A136020		Torx T40	Ø 4-5 x 30mm
34 x 60	A136023		TH 10	Ø 5-6 x 30mm
34 x 90	A136025		TH 13	Ø 6-7 x 70mm

CHEVILLE TAMPON VRAC - POUR PATTE À VIS

Ø x L (mm)	Référence	Condt
8 x 40 VRAC	A170380	Boîte de 100
	A172840	Seau de 300
	A172845	Seau de 2000



CHEVILLE PLAK-MÉTAL + P.A.V. M7

► Pour plaque de plâtre



Ø x L (mm)	Référence	Condt
4,2 x 35	A200000	Boîte de 100

IZY - OUTIL DE VISSAGE ET DÉVISSAGE

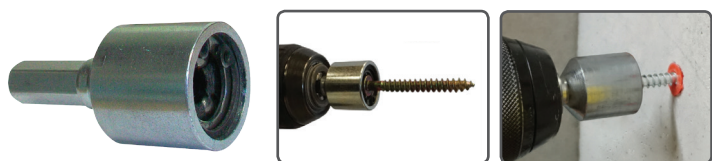

CARACTÉRISTIQUES

- Permet le vissage et le dévissage (en rénovation par exemple)
- Ne détériore pas le filet des pattes à vis
- Gain de temps et facilité de pose
- La patte à vis tient seule dans l'outil

Visser lentement



Désignation	Référence	Condt
IZY 6 pour tige filetée M6	A149990	Blister unitaire
	A149995	Minibox de 21
IZY 7 pour patte à vis M7	A150003	Blister unitaire
	A150004	Minibox de 21
IZY 8 pour patte à vis M8	A150045	Blister unitaire
	A150046	Minibox de 21
IZY 10 pour patte à vis M10	A150050	Blister unitaire
	A150051	Minibox de 21

AGRAFE - POUR LA FIXATION DE TUBES SUR DES DALLES EN POLYSTYRÈNE

AGRAFE THERMO-SOUDÉE

Désignation	Référence	Condt	Surcondt 1	Surcondt 2
Agrafe 40 mm	A520050	Boîte de 300	Carton de 16 boîtes	Palette de 400 boîtes
Agrafe 60 mm	A520060	Boîte de 300	Carton de 12 boîtes	Palette de 300 boîtes

Désignation	Référence	Condt
Outil de pose	A520020	Unité



AGRAFE BANDE PAPIER

Désignation	Référence	Condt	Surcondt 1	Surcondt 2
Agrafe 40 mm	A520055	Boîte de 300	Carton de 16 boîtes	Palette de 400 boîtes
Agrafe 60 mm	A520065	Boîte de 300	Carton de 12 boîtes	Palette de 300 boîtes

FIXALU® - ANCRAGE PERFORMANT SUR PAROI MÉTALLIQUE FINE

POUR CHANTIER

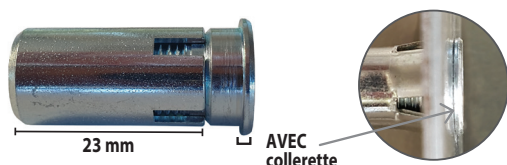

CARACTÉRISTIQUES

- Fixation en acier
- M6 : pour épaisseur de tôle jusqu'à 2 mm
- M8 : pour épaisseur de tôle jusqu'à 3 mm
- Applications : colliers sanitaires, panneaux sandwichs, etc.

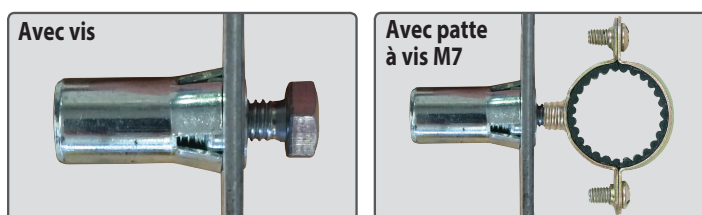

Taraudage	Référence	Condt	Ø perçage
M6	A140270	Boîte de 30	12,5 mm
	A140272	Sachet de 10	
M8	A140280	Boîte de 15	14,5 mm
	A140290	Sachet de 5	

RAPIDO® - PITON DE SUSPENSION DIRECT BÉTON



Agrément en cours

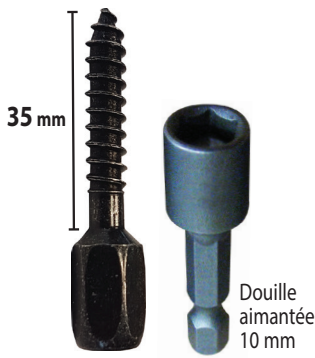

NOUVEAU : GAIN DE TEMPS + de tenue / + facile à visser



Tarudage	Référence	Condt	Surcondt
M6	A188090	Boîte de 100	Carton de 10 boîtes
M7	A188100		
M8	A188150		
Outil de pose	A270345	Unité	-

- ▶ **Pas de cheville : pose rapide !**
- ▶ Marteau interdit : utiliser une visseuse
- ▶ Applications : chemin de câbles, luminaires, climatisations...
- ▶ Charges pondérées avec coefficient de sécurité de 3 : **100 kg**

PITON RÉNOVATION FEMELLE - PITON DE SUSPENSION DIRECT BOIS

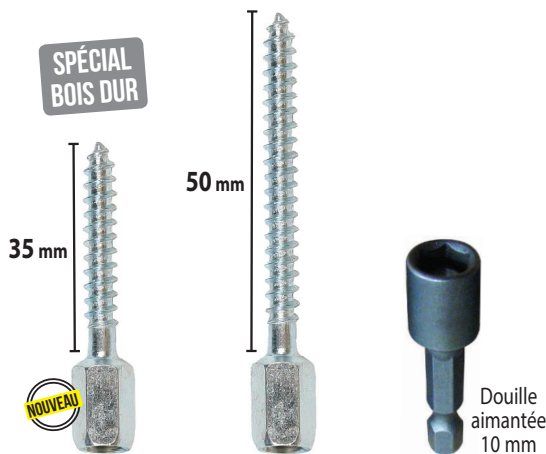

SPÉCIAL BOIS DUR

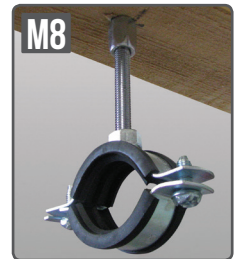

Tarudage	Référence	Condt	Finition	Surcondt
NOUVEAU M6 - lg. 35 mm	A270305	Boîte de 100	Zinguée blanche	6 Boîtes
M6	A270310		Zinguée jaune	
M7	A270320			
M8	A270325			
NOUVEAU M10 *	A270330	Boîte de 20	Zinguée blanche	10 Boîtes
Outil de pose	A270345	Unité		-

* Pré-perçage ø 6 + vissage à l'aide d'une douille de 12

- ▶ Sans préperçage : **vissage direct dans le bois**
- ▶ Charges pondérées avec coefficient de sécurité de 3 :
M6 - M7 - M8 : **100 kg**
M10 : **150 kg**

CHEVILLE DOUILLE MÉTALLIQUE

- ▶ Profondeur d'ancrage réduite : possibilité de fixation dans un support de faible épaisseur
- ▶ Résistante au feu

Tarudage	L (mm)	Référence	Condt
M6	25	A260160	Boîte de 100
M7	30	A260165	
M8	30	A260170	
M10	40	A260175	

Tarudage	L (mm)	Référence	Condt
M12	50	A260180	Boîte de 50
M16	60	A260190	Boîte de 25
M20	80	A260195	Boîte de 20





I = largeur H = hauteur
L = longueur E = épaisseur

PROFIL ACIER

I (mm)	H (mm)	L (m)	E (mm)	Référence	Condt	Finition	Infos lumières
27	18	2m	1,2	A184845	Unité	Zinguée	H = 9 mm l = 25 mm
	18	3m	1,2	A184840	Unité	Zinguée	Distance au centre de deux lumières : 50 mm
35	19	2m	1,5	A184810	Unité	Zinguée	H = 12 mm l = 20 mm
	35	3m	2	A184820	Unité	Zinguée	Distance au centre de deux lumières : 40 mm
41	21	3m	2	A184850	Unité	Zinguée	H = 13 mm l = 30 mm
	41	3m	2	A184860	Unité	Zinguée	Distance au centre de deux lumières : 50 mm

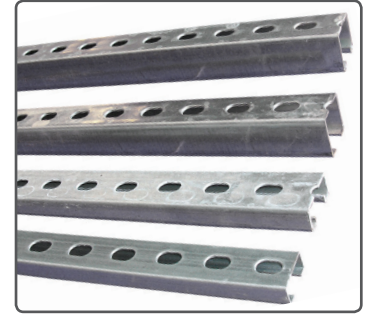

MANCHON DE RACCORDEMENT - POUR PROFILS ACIER LARGEUR 41MM

I (mm)	H (mm)	L (mm)	E (mm)	Référence	Condt	Finition	Infos trous
42	21	200	1	A184870	Boîte de 10	Zinguée	Ø 13mm
43	41	200	2	A184875	Boîte de 10	Zinguée	Ø 13mm

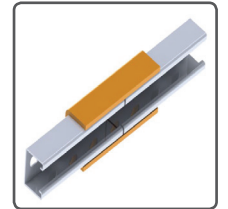

PLAQUE DE VEROUILLAGE - POUR PROFILS ACIER LARGEUR 41MM

► Permet de renforcer la stabilité du rail

Plaque de verrouillage	E (mm)	Référence	Condt	Finition
M8	2	A184880	Boîte de 10	Zinguée

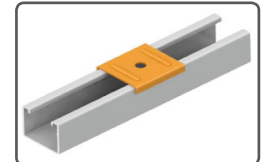
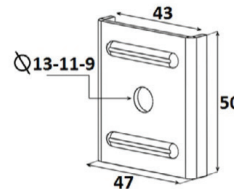

PLAQUE D'ASSEMBLAGE - POUR PROFILS ACIER LARGEUR 41MM

► Pour assembler deux profils acier

Plaque d'assemblage	Référence	Condt	Finition
Plaque 4 trous	A184884	Boîte de 10	Zinguée
Plaque en L	A184886	Boîte de 10	Zinguée
Plaque en T	A184887	Boîte de 10	Zinguée

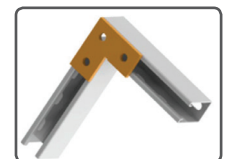
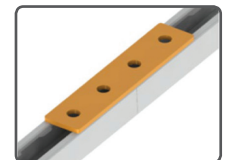
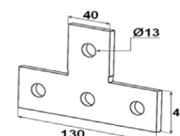
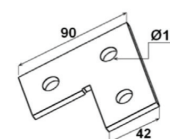
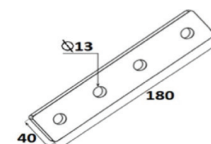

ÉQUERRE D'ASSEMBLAGE - POUR PROFILS ACIER LARGEUR 41MM

► Pour assembler deux profils acier

Équerre d'assemblage	Référence	Condt	Finition
Équerre 2 trous 90°	A184890	Boîte de 10	Zinguée
Équerre 4 trous 90°	A184892		
Équerre 3 faces 90°	A184899		
Équerre ouverte 45°	A184905		

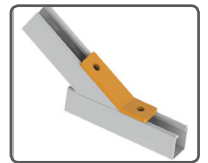
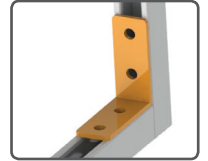
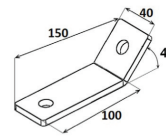
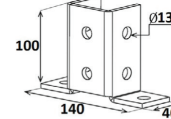
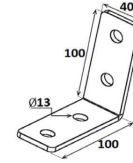
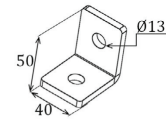

RACCORDEMENT OMEGA - POUR PROFILS ACIER LARGEUR 41MM

► Pour assembler deux profils acier par superposition

Profil acier (mm)	Référence	Condt	Finition
41 x 21	A184894	Boîte de 10	Zinguée
41 x 41	A184895		

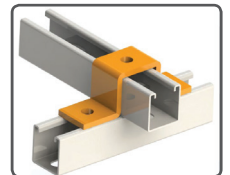
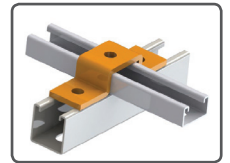
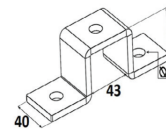
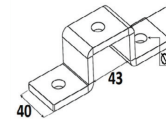

ÉCROU COULISSANT CRANTÉ - POUR PROFILS ACIER LARGEUR 41MM

Écrou	Filetage (mm)	Référence	Condt	Finition
Basique	M8	A184915	Boîte de 10	Zinguée
	M10	A184920		
	M12	A184930		
Automatique	M8	A184936	Boîte de 20	
	M10	A184938		
	M12	A184940		

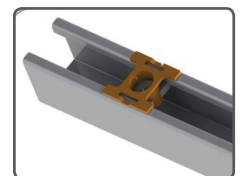
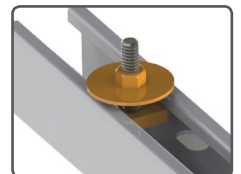
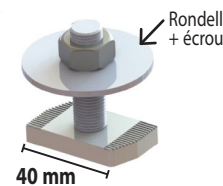

EMBOUT PROTECTEUR - POUR RAILS, CONSOLES ET PROFILS

Profil acier (mm)	Référence	Condt	Finition
41 x 21	A185122	Boîte de 20	Plastique noir
41 x 41	A185124		

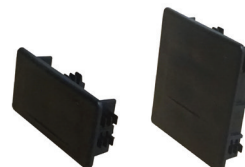



PIED - POUR PROFILS ACIER LARGEUR 41MM

► Avec écrou coulissant pré-monté

Pieds	E (mm)	Référence	Condt	Finition
Pour profil acier léger	5	A185180	Boîte de 10	Zinguée
Pour profil acier lourd	6	A185185		
Pour profil acier carré	5	A185190		

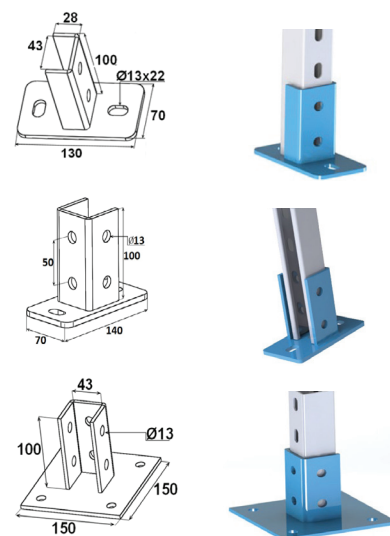

ACCESSOIRES POUR PROFILS ACIER

Produits	Référence	Condt	Finition	Contenu du sachet
Équerre 45°	A180010	Boîte de 20	Zinguée	1 équerre 45°, 2 plaquettes filetées M8, 2 vis métaux TH Ø8 x 16 - embase
Équerre 90°	A180012			1 équerre 90°, 2 plaquettes filetées M8, 2 vis métaux TH Ø8 x 16 - embase
Plaquette filetée M8	A180014			1 plaquette filetée M8, 1 tige filetée Ø8 x 30, 1 contre plaquette M8 1 rondelle et 1 écrou Ø8
Plaquette filetée M10	A180016			2 plaquettes filetées M10, 1 tige filetée Ø10 x 30, 1 rondelle et 1 écrou Ø10

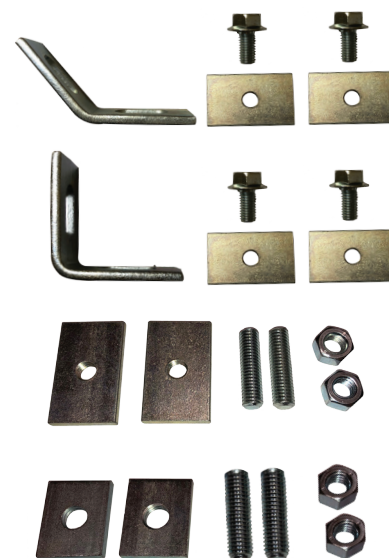

AGRIP-TIGE

Ø Trou lisse (mm)	Référence	Condt	Finition	Ouverte mâchoire
6	A180020	Boîte de 20	Zinguée	18 mm
8	A180021			18 mm
10	A180022			19 mm
12	A180023			25 mm

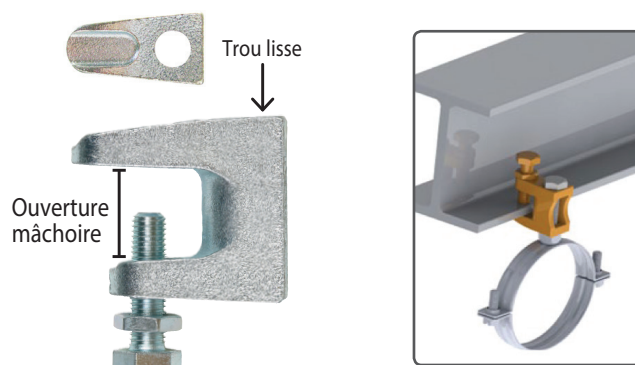

CONSOLE - POUR LA FIXATION DE TUYAUTERIE

I x H (mm)	L (mm)	E (mm)	Référence	Condt	Finition	Infos lumières profil
27 x 18	200	1,2	A184960	Boîte de 20	Zinguée	H = 9 mm l = 25 mm
	300	1,2	A184970	Boîte de 20		
41 x 21	200	2	A185000	Boîte de 25		H = 13 mm l = 22 mm
	300	2	A185020	Boîte de 15		
41x 41	200	2	A185040	Boîte de 15		
	300	2	A185050	Boîte de 12		
	400	2	A185060	Lot de 5		
	500	2	A185080	Lot de 5		
	600	2	A185100	Lot de 5		
	750	2	A185110	Lot de 5		
1000	2	A185120	Lot de 5			

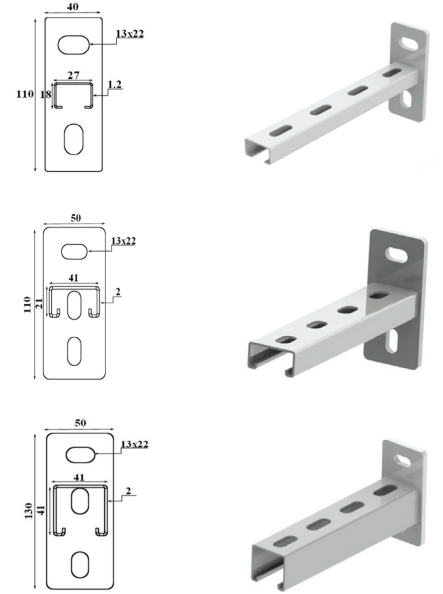

RENFORT POUR CONSOLE

L (mm)	Référence	Condt	Finition
300 mm	A185130	Boîte de 5	Zinguée
600 mm	A185135	Boîte de 5	



FIX-PLATINE - POUR LES CHEMINS DE CÂBLES EN DALLE ET EN FIL

Matériau	Référence	Condt	Finition
Poutrelle Métallique*	A183600	Boîte de 5	Zinguée Blanche
Parpaing + isolation	A183100	Boîte de 10	Zinguée

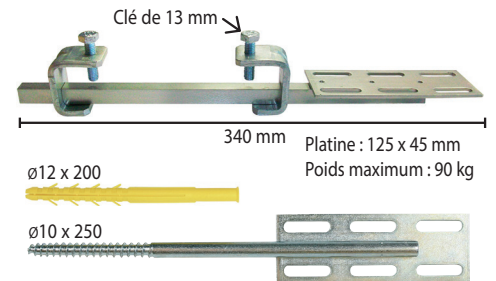

* Largeur I.P.N. : 70 à 150 mm - Épaisseur I.P.N. : 5 à 15 mm

CRAPAUD - POUR PROFILS ACIER LARGEUR 41MM

► Pour une fixation sans perçage ni soudure sur les constructions en acier et poutrelles métalliques

Filetage	Référence	Condt	Finition
M6	A180019	Boîte de 20	Zinguée
M8	A185150	Boîte de 25	
M10	A185170	Boîte de 25	



SUPPORT RENFORCÉ - PROFILS 41 X 41 MM

L (mm)	Référence	Condt	Finition
450 mm	A185140	Lot de 2	Zinguée
600 mm	A185142		

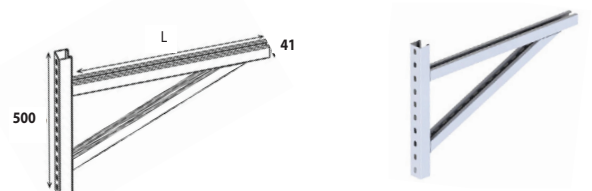

CONSOLE RAIL UNIVERSELLE - POUR CHEMINS DE CÂBLE EN FILS ET EN TÔLE

- ▶ Pattes rabattables sur les mailles des chemins de câbles
- ▶ Adaptées à tous les chemins de câbles du marché

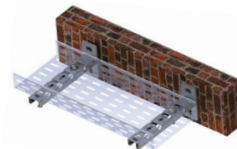
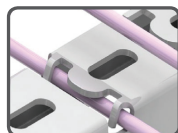

I x H (mm)	L (mm)	E (mm)	Référence	Cond	Finition	Infos lumières profil
41 x 21	150	2	A185360	Boîte de 25	Zinguée	H = 13 mm l = 22 mm
	200	2	A185362	Boîte de 25		
	300	2	A185363	Boîte de 10		
41 x 41	300	2	A185372	Boîte de 16		H = 13 mm l = 22 mm
	400	2	A185374	Boîte de 8		
	500	2	A185375	Boîte de 8		
	600	2	A185376	Boîte de 8		

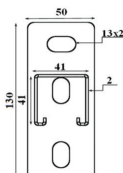
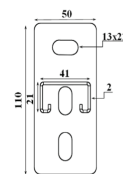

CONSOLE ENCLIQUETABLE UNIVERSELLE

- ▶ Installation facile et rapide sur pendard 3 faces et omega encliquetable
- ▶ Pattes rabattables sur les mailles des chemins de câbles
- ▶ Adaptées à tous les chemins de câbles du marché

L (mm)	Référence	Cond	Finition
100	A185580	Boîte de 10	Zinguée
150	A185582		
200	A185584		
300	A185586		
400	A185588		
500	A185589		

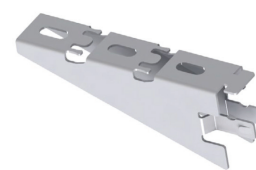
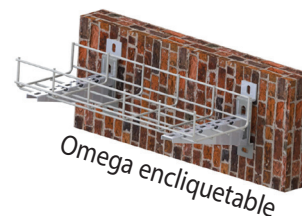
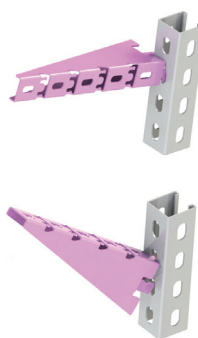

PENDARD - PROFIL 41 X 41 MM - 3 FACES

- ▶ Idéal pour les fixations au plafond
- ▶ Indispensable pour une utilisation des consoles encliquetables
- ▶ Perforation 13 x 30 sur les côtés

L (mm)	Référence	Cond	Finition
300	A185550	Lot de 4	Zinguée
400	A185552		
500	A185554		
600	A185556		
800	A185560	Lot de 2	
1000	A185562		

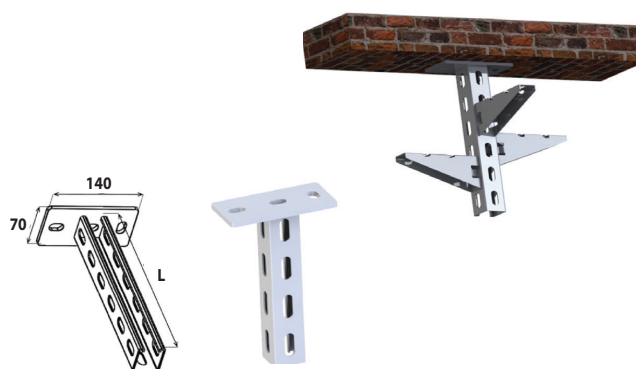

OMÉGA ENCLIQUETABLE

- ▶ Indispensable pour la fixation murale des consoles encliquetables
- ▶ Perforation 13 x 30 sur les côtés
- ▶ Renforcé au niveau

Désignation	Référence	Cond	Finition
OMÉGA ENCLIQUETABLE	A185192	Boîte de 20	Zinguée

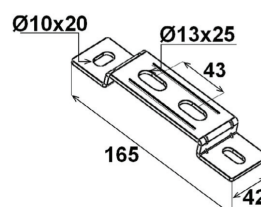

ÉQUERRE UNIVERSELLE LWU - POUR LES CHEMINS DE CÂBLES EN FILS ET EN TÔLE

- Fixation murale
- Système de renfort au niveau des plis
- Pattes rabattables sur les mailles des chemins de câbles

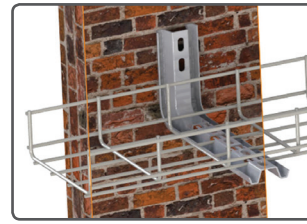

Chemin de câble en fils



Chemin de câble en tôle

L (mm)	Référence	Condt	Finition
100	A185200	Boîte de 25	Zinguée
150	A185210	Boîte de 25	
200	A185220	Boîte de 25	
300	A185240	Boîte de 15	
400	A185245	Boîte de 10	
500	A185250	Boîte de 10	

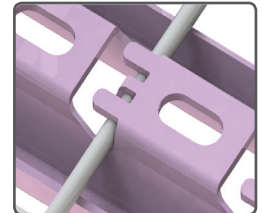
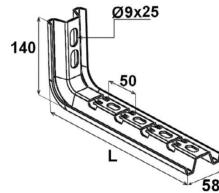

ÉQUERRE UNIVERSELLE CWU - POUR LES CHEMINS DE CÂBLES EN FILS ET EN TÔLE

- Fixation au plafond
- Système de renfort au niveau des plis
- Pattes rabattables sur les mailles des chemins de câbles



Chemin de câble en fils



Chemin de câble en tôle

L (mm)	Référence	Condt	Finition
100	A185300	Boîte de 15	Zinguée
150	A185310	Boîte de 12	
200	A185320	Boîte de 12	
300	A185340	Boîte de 10	
400	A185345	Boîte de 10	
500	A185350	Boîte de 10	

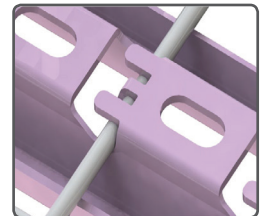
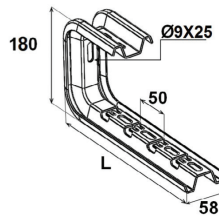

ÉTRIÉR - SUPPORT DE TUYAUTERIES INDUSTRIELLES

Ø (mm)	Éq. pouce	Référence	Condt	H (mm)	D (mm)	F (mm)	Filetage
17	3/8"	A185610	Sachet de 10	38	23,3	22	M6
21	1/2"	A185615		42	27,3	24	M6
27	3/4"	A185620		50	36	28	M8
34	1"	A185625		56	42	30	M8
42	1" 1/4	A185630		70	52	35	M8
49	1" 1/2	A185635		72	58	35	M8
60	2"	A185650		85	70	35	M8
76	2" 1/2	A185655		113	87	45	M10
90	3"	A185660		120	102	45	M10
114	4"	A185675		155	127	50	M12
168	6"	A185690		220	186	85	M14

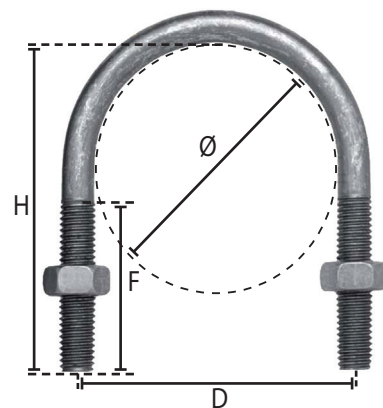

FIX-RING MULTI® ÉLECTRICITÉ - POUR LA FIXATION DE TUBE IRO ET GAINE ICT

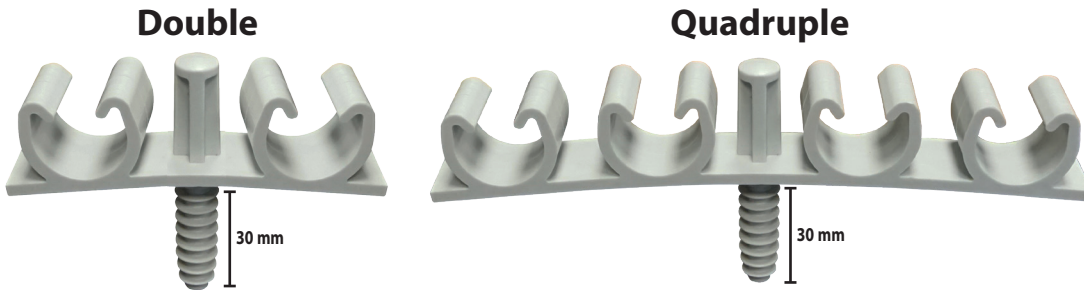
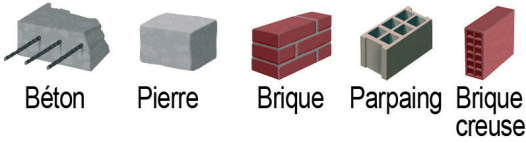

Ø 8 mm
ou Ø 10 mm

Percez



Frappez



Le FIX-RING MULTI® quadruple est mis en place !



Tube IRO



Gaine ICT



Box de 20 boîtes

CARACTÉRISTIQUES

- ▶ Polyamide 6
- ▶ Multi-diamètre
- ▶ Travail plus juste : le fait de fixer les tuyaux avant permet de minimiser les chutes
- ▶ Tous matériaux
- ▶ Perçage Ø 8 mm (Ø 16 à 20)
Ø 10 mm (Ø 22 à 26)
- ▶ Percer - Frapper avec un marteau - C'est fixé !

FIX-RING Multi®	Ø (mm)	Référence	Cond	Surcond
Double	16 à 20	A331000	Boîte de 50	Carton de 12 boîtes
	22 à 26	A331200	Boîte de 40	
FIX-RING Multi®	Ø (mm)	Référence	Cond	Surcond
Quadruple	16 à 20	A331100	Boîte de 25	Carton de 12 boîtes
	22 à 26	A331300	Boîte de 20	

FIXATION DE TUBES IRO SUR TÔLE ET BARDAGE - RAPID-TUB



Le tube est bloqué !

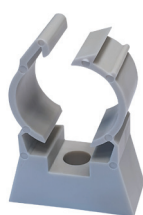

SIMPLE

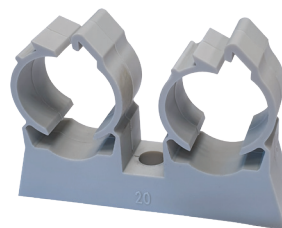

DOUBLE



Vis 4,8 x 25 fournis

RAPID-TUB	Ø (mm)	Référence	Condt
SIMPLE	20	A313210	Boîte de 50
		A313200	Boîte de 100
		A854255	Sachet de 5
DOUBLE	20	A313230	Boîte de 30
		A313220	Boîte de 50
		A854260	Sachet de 5

CARACTÉRISTIQUES

- ▶ Rapidité de mise en oeuvre : vissez, cliquez, c'est fixé !
- ▶ Clipsage à la main
- ▶ Durabilité et sécurité : ne s'ouvre pas
- ▶ 100% nylon polyamide 6

FIX-RING +® - FIXATION DE TUBES ÉLECTRIQUES



Béton



Pierre



Brique



Parpaing



Brique creuse

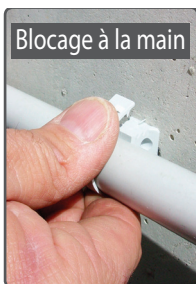

Blocage à la main



Tube bloqué et non clipsé = sécurité



30 mm

Ø (mm)	Référence	Condt	Surcondt
16	A311000	Boîte de 100	Carton de 16 boîtes
20	A311500	Boîte de 100	
25	A312000	Boîte de 75	

CARACTÉRISTIQUES

- ▶ Polyamide 6 - Stabilisé UV - Ignifugé
- ▶ Auto-extinguible (ne porte pas la flamme)
- ▶ Percer Ø 8 mm - Frapper avec un marteau sur l'outil de pose - c'est fixé !
- ▶ Outil de montage fourni - réouverture possible

FAST-RING - ATTACHE POUR FIXER UN TUBE SUR UN TUBE EXISTANT

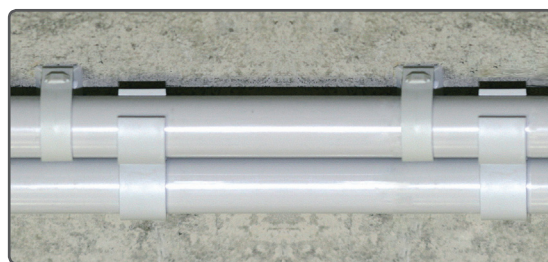
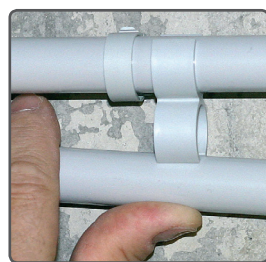

CARACTÉRISTIQUES

- ▶ Polyamide 6
- ▶ Pas de perçage : parfaitement rectiligne
- ▶ Auto-extinguible (ne porte pas la flamme)

Ø (mm)	Référence	Condt	Surcondt
16 - 16	A312100	Boîte de 100	Carton de 16 boîtes
20 - 20	A312150		

PASS-RING - POUR FACILITER LE PASSAGE DES GAINES DANS LES RAILS

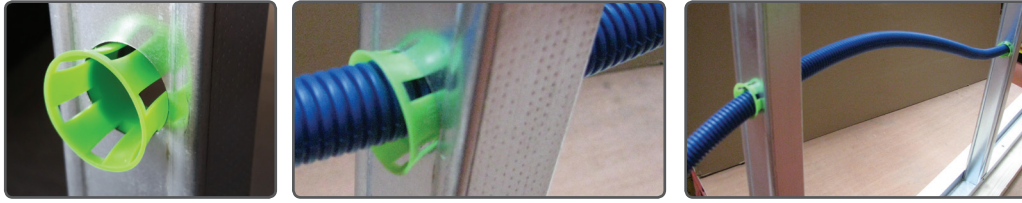

Ø 16 à Ø 20

Ø (mm)	Référence	Condt	Ø Gains (mm)
16 à 20	A312310	Sachet de 50	16 - 20

CARACTÉRISTIQUES

► Facile, rapide et pratique !

OUTIL AIMANTÉ PRATICO - POUR DIFFÉRENTES APPLICATIONS



CLIP BORD DE TÔLE

CHEVILLE GOLD

POINTE

VIS

ÉCROU



« CLIC »

Le clip tient tout seul !

UNE NOUVELLE FAÇON DE POSER : + FACILE !



Désignation	Référence	Condt
Outil aimanté PRATICO	A200195	Sachet de 1

MANCHONS DE RACCORDEMENT



CONNECT-RING® - POUR GAINES ICT ET TUBES IRO

- Polypropylène - Ignifugé V2
- Démontable
- Peut se mettre en place même si les fils sont tirés

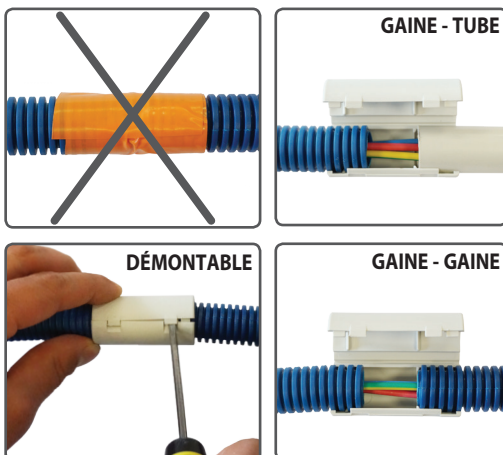

GAINE - TUBE

DÉMONTABLE

GAINE - GAINÉ

Ø (mm)	Référence	Condt	Surcondt
16	A320100	Boîte de 50	Carton de 16 boîtes
	A320500	Sachet de 15	Carton de 10 sachets
20	A320200	Boîte de 50	Carton de 16 boîtes
	A320600	Sachet de 15	Carton de 10 sachets
25	A320300	Boîte de 40	Carton de 16 boîtes
	A320700	Sachet de 10	Carton de 10 sachets
32	A320400	Boîte de 20	Carton de 16 boîtes
	A320800	Sachet de 5	Carton de 10 sachets

Une autre façon de travailler : fini les chutes de gaines inutilisées !

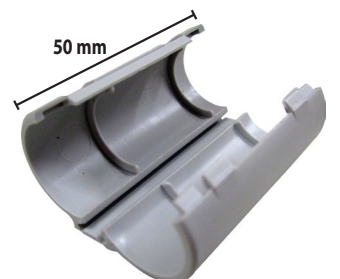

ECO-RING - POUR GAINES ICT

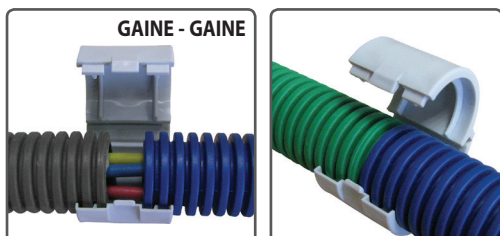

GAINE - GAINÉ

Ø (mm)	Référence	Condt	Surcondt
16	A320010	Boîte de 100	Carton de 12 boîtes
	A320040	Sachet de 15	Carton de 10 sachets
20	A320020	Boîte de 100	Carton de 12 boîtes
	A320050	Sachet de 15	Carton de 10 sachets

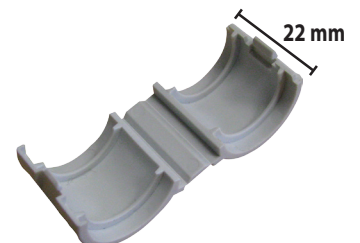

SPEEDY-FIX® - SUSPENTE DIRECTE BÉTON



CARACTÉRISTIQUES

- ▶ Pas besoin de cheville = pose rapide
- ▶ Outil de pose fourni
- ▶ Charges pondérées de rupture : 500 kg
- ▶ Charges pondérées coefficient de sécurité de 3 appliqué : **100 kg**
- ▶ **Applications :** chaînettes, fils d'acier, crochets, mousquetons, caletttes, tiges lisses, chemins de câbles, etc...

Désignation	Référence	Condt
SPEEDY-FIX	A858850	Sachet de 50
	A270350	Boîte de 100
	A270348	Seau de 200
Outil de pose	A270355	Unité

COLLIER ÉLECTRICIEN - STABILISÉ UV - POLYAMIDE 6



Ouverture pratique : les colliers restent en place dans le sachet même après ouverture

Ø x L (mm)	Finition	Référence	Condt
2,4 x 95	Noire	A280030	Sachet de 100
2,4 x 200	Noire	A280040	
3,6 x 150	Noire	A280050	
4,6 x 200	Noire	A280060	
4,8 x 300	Noire	A280065	
4,8 x 385	Noire	A280070	
7,6 x 200	Noire	A280075	
9,0 x 510	Noire	A280080	

Ø x L (mm)	Finition	Référence	Condt
9 x 200	Noire	A280000	Sachet de 100
9 x 290	Noire	A280010	
9 x 380	Noire	A280020	

Ø x L (mm)	Finition	Référence	Condt
2,4 x 95	Blanche	A280090	Sachet de 100
2,4 x 200	Blanche	A280100	
3,6 x 150	Blanche	A280110	
4,6 x 200	Blanche	A280120	
4,8 x 300	Blanche	A280125	
4,8 x 385	Blanche	A280130	
9,0 x 910	Blanche	A280350	

COLLIER AÉRAULIQUE

- ▶ Pour le serrage de gaines de ventilation et de climatisation

Ø x L (mm)	Finition	Référence	Condt
9 x 910	Blanche	A280350	Sachet de 100
9 x 1200	Blanche	A280355	

ACCESSOIRES COLLIERS ÉLECTRICIENS



Désignation	Référence	Condt
Cheville	A280140	Sachet de 100

Désignation	Référence	Condt
Embase	A280145	Sachet de 100

Désignation	Référence	Condt
Pince	A280150	Unité

GOULOTTE DE PROTECTION 1M - POUR PROTÉGER LES TUYAUX DE GAZ

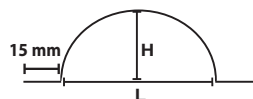

H x L (mm)	Référence	Condt	Tube (mm)
45 x 45	A180505	10	ø 8 - ø 18
70 x 70	A180510		ø 28 - ø 32
90 x 90	A180515		ø 35 - ø 54

CARACTÉRISTIQUES

- ▶ Aluminium
- ▶ Épaisseur 12/10 ème
- ▶ Pré-perforée pour fixations

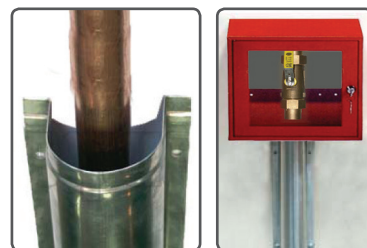

FEUILLARD - POUR SUSPENDRE LES GAINES, CONDUITS ET TUYAUX

FEUILLARD PERFORÉ

I x Ep (mm)	L rouleau	Référence	Condt	Poids max.
12 x 0,8	10 m	A190110	5 Rouleaux	70 kg
17 x 0,6	25 m	A190000		105 kg
20 x 0,6	25 m	A190010		170 kg
25 x 0,75	25 m	A190020		250 kg

Rouleau de 10 m

Rouleau de 25 m

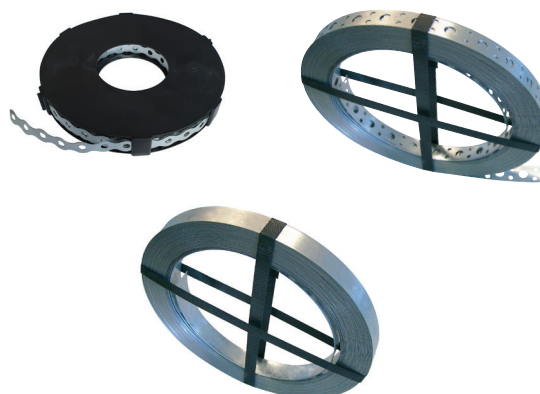

FEUILLARD NON PERFORÉ

I x Ep (mm)	L rouleau	Référence	Condt	Poids max.
17 x 0,6	25 m	A190030	5 Rouleaux	105 kg

SUSPENTE FEUILLARD - CHEVILLE POUR SUSPENSION DE FEUILLARD



Béton



CARACTÉRISTIQUES

- ▶ Rapide : expansion par frappe avec un marteau
- ▶ Faible profondeur d'ancrage
- ▶ Charge de rupture : 90 kg
- ▶ Indémontable

Ø x L (mm)	Référence	Condt	Ø Perçage (mm)
6 x 35	A270015	Boîte de 100	6

PIQUET DE TERRE ET ACCESSOIRES - POUR LA SÉCURITÉ DES INSTALLATIONS ÉLECTRIQUES

PIQUET DE TERRE



CARACTÉRISTIQUES

- ▶ 100% Acier galvanisé
- ▶ Forme de trèfle ø16
- ▶ Conforme norme EN ISO 1461

L	Référence	Condt
1 m	A199600	Lot de 10
1,5 m	A199620	
2 m	A196625	

BARETTE COUPURE DE TERRE

POUR MESURER LA PRISE DE TERRE



Référence	Condt	Finition
A199650	Boîte de 10	Socle en plastique et section de cuivre 12mm ²

COLLIER LANGUETTE

POUR LIAISON ÉQUIPOTENTIELLE



Référence	Condt	Finition	Ø Serrage
A199660	Boîte de 10	Tête en Acier et languette en Inox	12 à 32 mm

I.N.G. FIXATIONS

Le choix du PRO !



N'hésitez pas à nous demander les coordonnées du technico-commercial de votre secteur !

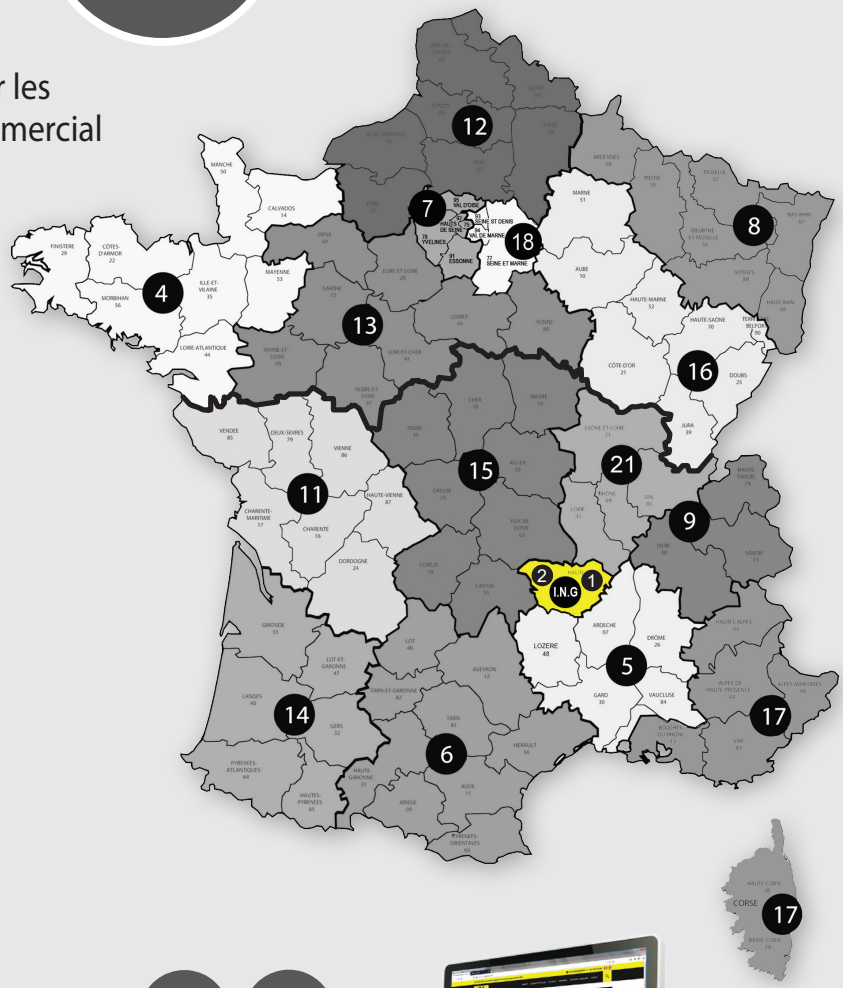

NOUS CONTACTER

Par courrier :
Z.I. de Chassende
43000 Le Puy-en-Velay
FRANCE

Par téléphone :
+33 (0)4 71 05 59 03

Par mail :
servicecommercial@ingfixations.fr
commandes@ingfixations.fr



Rendez-vous sur
notre site internet
www.ingfixations.fr



Distributeur

